

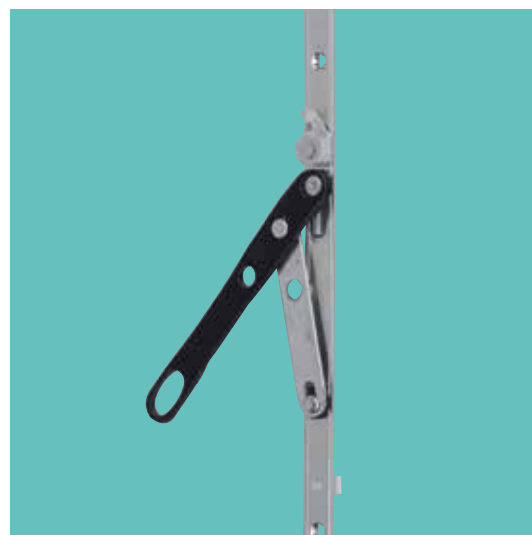

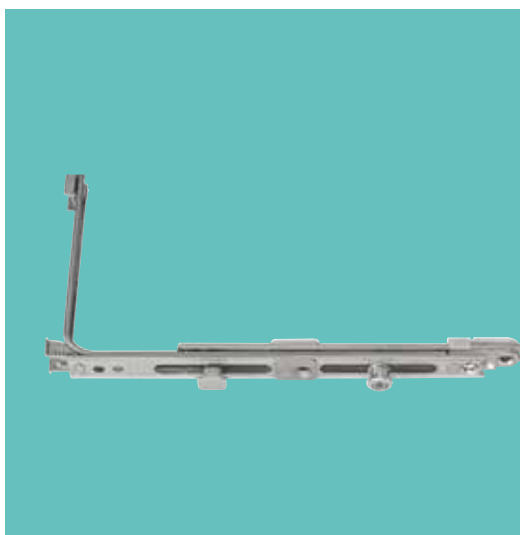

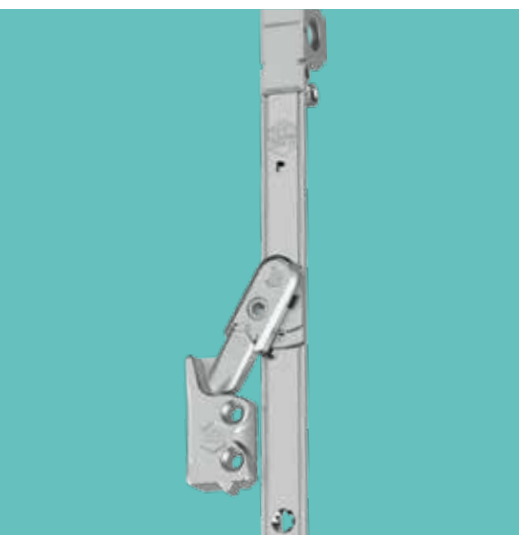

































TECHNIKA V POHYBU

# MACO MULTI-MATIC

OTVÍRAVÉ A OTVÍRAVĚ  
SKLOPNÉ KOVÁNÍ



KATALÓG

	Pro dřevěná okna		VERSATZ - odstup kovací drážky
	Pro plastová a hliníková okna		Hloubka falzu (FT)
	Objednací číslo		Max.přípustná hmotnost křídla
	TRICOAT-číslo		Počet i.S. čepů
	FFB - šířka nebo FFH - výška		Počet uzavíracích čepů
	FFB - šířka křídla v drážce kování		Polohovací pojistka
	Šířka křídla v drážce kování s rohovým převodem		Průměr vrtutů
	Šířka křídla v drážce kování s krátkým rohovým převodem		Šířka štulpu
	FFB pro okna s obloukem/segmentem		Čtyřhran
	FFB pro oblouky		Rozteč (E)
	FFB pro šikmá okna		Tloušťka podložky
	FFH - výška křídla v drážce kování		Počet vrtutů
	FFH s rohovým převodem krátkým	<b>B</b>	Celková šířka dílu
	FFH pro okna s obloukem/segmentem	<b>L</b>	Celková délka dílu
	Konstantní převodovka		Balící množství
	Variabilní převodovka		Paletové množství
	DM (dorn)	MM =	MULTI-MATIC
	Výška kliky GM	MT =	MULTI-TREND
	Pantová strana	MP =	MULTI POWER
	Centrální uzamykání (ZV)	KS =	Sklopný čep KS
	Falzluft (FL)	DK =	OS-otvíravě sklopné
	Naléhavka (Ü)	KD =	SO-sklopně otvíravé
		DR =	Otvíravé
		FFB =	Šířka křídla v drážce kování
		FFH =	Výška křídla v drážce kování
		FT =	Hloubka falcu (FT)
		L =	LUFT - vůle mezi křídlem a rámem (FL)
		V =	VERSATZ - odstup kovací drážky
		AS =	Našroubovatelné (bez frézování)



### 3 Převodovky

---

#### 3.1 OS-převodovky

---

- 3.1.1 OS-převodovky DM 15
- 3.1.2 OS-převodovky DM 6,5
- 3.1.3 OS-převodovky DM -6
- 3.1.4 OS-převodovky zvláštní DM i.S.
- 3.1.5 OS-převodovky uzamykatelné zvláštní DM i.S.

#### 3.2 O-převodovky

---

- 3.2.1 O-převodovky DM 15
- 3.2.2 O-převodovky DM 6,5
- 3.2.3 O-převodovky zvláštní DM i.S.
- 3.2.4 O-převodovky zvláštní DM variabilní VZ
- 3.2.5 O-převodovky pro oblouková okna i.S.

#### 3.3 Příslušenství převodovek

---

- 3.3.1 Dveřní západky
- 3.3.2 Podložky pod dveřní západky
- 3.3.3 Polohovací pojistky
- 3.3.4 Ochrany převodovky proti odvrtní
- 3.3.5 Prodloužení štulpu pro ALU-okna
- 3.3.6 Držáky štulpu pro krátké převodovky
- 3.3.7 Krytky zámku převodovky
- 3.3.8 Prodloužení pro náběh zvedače křídla
- 3.3.9 Příslušenství převodovek DM -6

#### 3.4 Hranové závory

---

- 3.4.1 Hranové závory DM 15
- 3.4.2 Hranové závory DM 6,5
- 3.4.3 Hranové závory s namontovanými sklopnými nůžkami

#### 3.5 Ukončení

---

- 3.5.1 Ukončení 90° (O)
- 3.5.2 Ukončení s 180° (OS, štulpové)
- 3.5.3 Ukončení horní pro oblouková okna
- 3.5.4 Sklopné ukončení pro převodovky
- 3.5.5 Ukončení spodní EH
- 3.5.6 Ukončení spodní pro otevíravá okna protiběžné
- 3.5.7 Ukončení horní pro protiběžné hranové závory

#### 3.6 Dveřní balkonové závory B-TV

---

- 3.6.1 Dveřní balkonové závory B-TV E85 s PZ
- 3.6.2 Dveřní balkonové závory B-TV E92 s PZ
- 3.6.3 Dveřní balkonové závory B-TV E94 s RZ







### 3 Převodovky

#### 3.1 OS-převodovky

##### 3.1.1 OS-převodovky DM 15

201734









3.1.1.1 OS-převodovky DM 15 fix i.S.								No	No Tricoat	
stříbrné	430	15	0	125	360 - 430	-	20	201730 <sup>1</sup>	207448 <sup>1*</sup>	
	660	15	0	190	431 - 660	1	20	201732 <sup>1</sup>	207449 <sup>1*</sup>	
	840	15	1	300	661 - 840	1	20	201733	207450*	
	1090	15	1	400	841 - 1.090	1	20	201734	207451*	
	1340	15	1	500	1.091 - 1.340	1	10	201735	207452*	
	1590	15	2	600	1.341 - 1.590	1	10	201739	207453*	
	1700	15	2	700	1.591 - 1.700	1	10	207301	207454*	
	1950	15	3	1.050	1.701 - 1.950	1	10	201740	207455*	
	2200	15	3	1.050	1.951 - 2.200	1	10	201741	207456*	
	2450	15	4	1.050	2.201 - 2.450	1	10	201742	207457*	
	s dveřní západkou	1950	15	3	1.050	1.701 - 1.950	1	10	201842	
		2200	15	3	1.050	1.951 - 2.200	1	10	201843	219075
		2450	15	4	1.050	2.201 - 2.450	1	10	201844	

<sup>1</sup> Použijte držák štolpu č. 213287 pro montáž.

212120









3.1.1.3 OS-převodovky DM 15 fix VZ s KS								No	No Tricoat	
stříbrné	430	15	0	125	360 - 430	-	20	209370 <sup>1</sup>	222657 <sup>1*</sup>	
	660	15	0	190	431 - 660	-	20	209371 <sup>1</sup>	222658 <sup>1*</sup>	
	840	15	1	300	661 - 840	1	20	212118		
	1090	15	1	400	841 - 1.090	1	20	212120		
	1340	15	1	500	1.091 - 1.340	1	10	212122		
	1590	15	2	600	1.341 - 1.590	1	10	212124		
	1700	15	2	700	1.591 - 1.700	1	10	212126		
	1950	15	3	1.050	1.701 - 1.950	1	10	212128		
	2200	15	3	1.050	1.951 - 2.200	1	10	212131		
	2450	15	4	1.050	2.201 - 2.450	1	10	212134		
	s dveřní západkou	1950	15	3	1.050	1.701 - 1.950	1	10	212129	
		2200	15	3	1.050	1.951 - 2.200	1	10	212132	
		2450	15	4	1.050	2.201 - 2.450	1	10	212135	

<sup>1</sup> Použijte držák štolpu č. 213287 pro montáž.

201737



<b>3.1.1.4 OS-převodovky EH DM 15 fix i.S.</b>								<b>No</b>	<b>No</b> Tricoat
stříbrné	660	15	1	190	431 - 660	-	10	<b>206986</b> <sup>1,2</sup>	<b>207458</b> <sup>1,2</sup>
			2	190	510 - 660	-	10	<b>214441</b> <sup>1,2</sup>	
	840	15	2	300	661 - 840	1	20	<b>201736</b> <sup>2</sup>	<b>207460</b> <sup>2*</sup>
	1090	15	2	400	841 - 1.090	1	20	<b>201737</b> <sup>2</sup>	<b>207461</b> <sup>2*</sup>
	1340	15	2	500	1.091 - 1.340	1	10	<b>201738</b> <sup>2</sup>	<b>207462</b> <sup>2*</sup>
	1590	15	3	600	1.341 - 1.590	1	10	<b>206847</b> <sup>2</sup>	<b>207463</b> <sup>2*</sup>
	1700	15	3	700	1.591 - 1.700	1	10	<b>207303</b> <sup>2,3</sup>	<b>207467</b> <sup>2,3*</sup>







<sup>1</sup> Použijte držák štolpu č. 213287 pro montáž.

<sup>2</sup> Použit u oken dle normy EN 1627.

<sup>3</sup> Od FFH 1700 použít OS-převodovku DM 15 fix i.S. zakrátit u rysky 170, následně prodloužit se spodním ukončením EH obj.č. 205644.

201747









<b>3.1.1.9 OS-převodovky DM 15 variabilní i.S.</b>		<b>L</b>							<b>No</b>	<b>No</b> Tricoat	
stříbrné	800	640	15	0	470 - 800	200	-	20	<b>201746</b> <sup>1</sup>	<b>207468</b> <sup>1*</sup>	
				1	590 - 800	159	1	20	<b>227936</b> <sup>1</sup>		
	1250	1.040	15	1	801 - 1.250	260	1	20	<b>201747</b>	<b>207469</b> *	
	1750	1.540	15	2	1.251 - 1.750	260	1	10	<b>201748</b>	<b>208318</b> *	
	2250	2.040	15	3	1.751 - 2.250	260	1	10	<b>202739</b>	<b>208319</b> *	
	s dveřní západkou		2250	2.040	15	3	1.751 - 2.250	260	1	10	<b>201749</b>

<sup>1</sup> Použijte držák štolpu č. 213287 pro montáž.

212156









<b>3.1.1.10 OS-převodovky DM 15 variabilní VZ</b>		<b>L</b>							<b>No</b>	<b>No</b> Tricoat
stříbrné	800	640	15	0	470 - 800	200	-	20	<b>201746</b> <sup>1</sup>	<b>207468</b> <sup>1*</sup>
	1250	1.040	15	1	801 - 1.250	260	1	20	<b>212156</b>	
	1350	1.140	15	1	901 - 1.350	260	1	20	<b>225098</b>	
	1750	1.540	15	2	1.251 - 1.750	260	1	10	<b>212158</b>	
	2250	2.040	15	3	1.751 - 2.250	260	1	10	<b>212160</b>	

<sup>1</sup> Použijte držák štolpu č. 213287 pro montáž.

\* TRICOAT-PLUS-Standardartikel







### 3.1.2 OS-převodovky DM 6,5



3.1.2.1 OS-převodovky DM 6,5 fix i.S.								No	No Tricoat	
stříbrné	660	6,5	0	190	455 - 660	-	20	202206 <sup>1</sup>	207470 <sup>1</sup>	
	840	6,5	1	300	661 - 840	1	20	202207	207471	
	1090	6,5	1	400	841 - 1.090	1	20	202208	207472	
	1340	6,5	1	500	1.091 - 1.340	1	10	202209	207473	
	1590	6,5	2	600	1.341 - 1.590	1	10	202216	207474	
	1700	6,5	2	700	1.591 - 1.700	1	10	207305	207475	
	1950	6,5	3	1.050	1.701 - 1.950	1	10	202737	207476	
	2200	6,5	3	1.050	1.951 - 2.200	1	10	202738	207477	
	s dveřní západkou	1950	6,5	3	1.050	1.701 - 1.950	1	10	202217	
		2200	6,5	3	1.050	1.951 - 2.200	1	10	202218	







<sup>1</sup> Použijte držák štolpu č. 213287 pro montáž.



3.1.2.3 OS-převodovky DM 6,5 fix VZ s KS								No	No Tricoat
stříbrné	660	6,5	0	190	455 - 660	-	20	212028 <sup>1</sup>	
	840	6,5	1	300	661 - 840	1	20	212048	
	1090	6,5	1	400	841 - 1.090	1	20	212049	
	1340	6,5	1	500	1.091 - 1.340	1	10	212050	
	1590	6,5	2	600	1.341 - 1.590	1	10	212052	
	1700	6,5	2	700	1.591 - 1.700	1	10	212054	
	1950	6,5	3	1.050	1.701 - 1.950	1	10	212055	
	2200	6,5	3	1.050	1.951 - 2.200	1	10	212057	





<sup>1</sup> Použijte držák štolpu č. 213287 pro montáž.



3.1.2.8 OS-převodovky DM 6,5 variabilní i.S.		L							No	No Tricoat
stříbrné	800	640	6,5	0	530 - 800	200	-	20	202491 <sup>1</sup>	207481 <sup>1</sup>
	1250	1.040	6,5	1	801 - 1.250	260	1	20	202492	207482
	1750	1.540	6,5	2	1.251 - 1.750	260	1	10	202494	207483
	2250	2.040	6,5	3	1.751 - 2.250	260	1	10	202205	207484

<sup>1</sup> Použijte držák štolpu č. 213287 pro montáž.











3.1.2.9 OS-převodovky DM 6,5 variabilní VZ		L						No	No Tricoat
stříbrné	800	640	6,5	530 - 800	200	-	20	202491 <sup>1</sup>	207481 <sup>1</sup>

<sup>1</sup> Použijte držák štolpu č. 213287 pro montáž.

### 3.1.3 OS-převodovky DM -6

218242 







3.1.3.1 OS-převodovky DM -6 fix i.S.									
stříbrné	660	-6	0	190	455 - 660	-	20	<b>218240</b> <sup>1,2,3</sup>	
	840	-6	1	300	661 - 840	1	20	<b>218241</b> <sup>1,2</sup>	<b>226434</b> <sup>1,2</sup>
	1090	-6	1	400	841 - 1.090	1	20	<b>218242</b> <sup>1,2</sup>	
	1340	-6	1	500	1.091 - 1.340	1	10	<b>218243</b> <sup>1,2</sup>	<b>226436</b> <sup>1,2</sup>
	1590	-6	2	600	1.341 - 1.590	1	10	<b>218244</b> <sup>1,2</sup>	
	1700	-6	2	700	1.591 - 1.700	1	10	<b>218245</b> <sup>1,2</sup>	
	1950	-6	3	1.050	1.701 - 1.950	1	10	<b>218246</b> <sup>1,2</sup>	<b>226439</b> <sup>1,2</sup>
2200	-6	3	1.050	1.951 - 2.200	1	10	<b>218247</b> <sup>1,2</sup>		

<sup>1</sup> Musí být použito i příslušenství pro převodovku DM - 6 (adaptér obj.č. 366719, mezikus např. 366006 ...).

<sup>2</sup> Na zámku převodovky nesmí být překročen max. kroutivý moment 22 Nm. Jinak musí být použita převodovka DM 6,5 s mezipřevodovkou.

<sup>3</sup> Použijte držák štlpu č. 213287 pro montáž.

218249 

3.1.3.2 OS-převodovky DM -6 variabilní i.S.								
stříbrné	800	-6	0	530 - 800	-	20	<b>218248</b> <sup>1,2,3</sup>	
	1250	-6	1	801 - 1.250	1	10	<b>218249</b> <sup>1,2</sup>	
	1750	-6	2	1.251 - 1.750	1	10	<b>218250</b> <sup>1,2</sup>	
	2250	-6	3	1.751 - 2.250	1	10	<b>218251</b> <sup>1,2</sup>	

<sup>1</sup> Musí být použito i příslušenství pro převodovku DM - 6 (adaptér obj.č. 366719, mezikus např. 366006 ...).







<sup>2</sup> Na zámku převodovky nesmí být překročen max. kroutivý moment 22 Nm. Jinak musí být použita převodovka DM 6,5 s mezipřevodovkou.

<sup>3</sup> Použijte držák štlpu č. 213287 pro montáž.

### 3.1.4 OS-převodovky zvláštní DM i.S.





205465



3.1.4.1 OS-převodovky zvláštní DM fix i.S.								No	No Tricoat
stříbrné	1090	30	1	400	841 - 1.090	1	20	212184	
	1340	30	1	500	1.091 - 1.340	1	10	212185	212199
	1950	25	3	1.050	1.701 - 1.950	1	10	205465	207485
		30	3	1.050	1.701 - 1.950	1	10	205473	207488
		35	3	1.050	1.701 - 1.950	1	10	205487	207491
		40	3	1.050	1.701 - 1.950	1	10	206402	
		45	3	1.050	1.701 - 1.950	1	10	206403	207497
		50	3	1.050	1.701 - 1.950	1	10	205491	
	2200	25	3	1.050	1.951 - 2.200	1	10	205464	
		30	3	1.050	1.951 - 2.200	1	10	205472	207489
		35	3	1.050	1.951 - 2.200	1	10	205480	207492
		40	3	1.050	1.951 - 2.200	1	10	205489	207495
		45	3	1.050	1.951 - 2.200	1	10	205490	207498
		50	3	1.050	1.951 - 2.200	1	10	205492	207501
	2450	25	4	1.050	2.201 - 2.450	1	10	206399	207487
		30	4	1.050	2.201 - 2.450	1	10	205479	207490
		35	4	1.050	2.201 - 2.450	1	10	205488	207493
		40	4	1.050	2.201 - 2.450	1	10	206400	207496
		45	4	1.050	2.201 - 2.450	1	10	206401	
		50	4	1.050	2.201 - 2.450	1	10	205493	

205514



3.1.4.2 OS-převodovky zvláštní DM variabilní i.S.		L						No	No Tricoat	
stříbrné	800	640	25	0	470 - 800	200	-	10	205513 <sup>1</sup>	207503 <sup>1</sup>
			30	0	470 - 800	200	-	10	205517 <sup>1</sup>	
			35	0	470 - 800	200	-	10	205525 <sup>1</sup>	
			40	0	470 - 800	200	-	10	205529 <sup>1</sup>	207515 <sup>1</sup>
			45	0	470 - 800	200	-	10	205539 <sup>1</sup>	
			50	0	470 - 800	200	-	10	205540 <sup>1</sup>	207523 <sup>1</sup>
	1250	1.040	25	1	801 - 1.250	260	1	10	205514	207504
			30	1	801 - 1.250	260	1	10	205518	207508
			35	1	801 - 1.250	260	1	10	205534	207512
			40	1	801 - 1.250	260	1	10	205530	207516
			45	1	801 - 1.250	260	1	10	206308	207520
			50	1	801 - 1.250	260	1	10	213071	
	1750	1.540	25	2	1.251 - 1.750	260	1	10	205532	207505
			30	2	1.251 - 1.750	260	1	10	205520	207509
			35	2	1.251 - 1.750	260	1	10	205535	
			40	2	1.251 - 1.750	260	1	10	205537	207517
			45	2	1.251 - 1.750	260	1	10	206309	207521
			50	2	1.251 - 1.750	260	1	10	213072	
	2250	2.040	25	3	1.751 - 2.250	260	1	10	205533	207506
			30	3	1.751 - 2.250	260	1	10	205531	207510
			35	3	1.751 - 2.250	260	1	10	205536	207514
40			3	1.751 - 2.250	260	1	10	205538	207518	
45			3	1.751 - 2.250	260	1	10	206310	207522	
50			3	1.751 - 2.250	260	1	10	213073	218909	

<sup>1</sup> Použijte držák štolpu č. 213287 pro montáž.



### 3.1.5 OS-převodovky uzamykatelné zvláštní DM i.S.

205602









3.1.5.1 OS-převodovky uzamykatelné zvláštní DM PZ fix i.S.								No	No Tricoat
stříbrné	1950	25	3	1.050	1.701 - 1.950	1	10	205602 <sup>1</sup>	207524 <sup>1</sup>
		30	3	1.050	1.701 - 1.950	1	10	205627 <sup>1</sup>	207527 <sup>1</sup>
		35	3	1.050	1.701 - 1.950	1	10	206153 <sup>1</sup>	207530 <sup>1</sup>
		40	3	1.050	1.701 - 1.950	1	10	206984 <sup>1</sup>	207533 <sup>1</sup>
		45	3	1.050	1.701 - 1.950	1	10	206155 <sup>1</sup>	207536 <sup>1</sup>
		50	3	1.050	1.701 - 1.950	1	10	206985 <sup>1</sup>	
	2200	25	3	1.050	1.951 - 2.200	1	10	205571 <sup>1</sup>	207525 <sup>1</sup>
		30	3	1.050	1.951 - 2.200	1	10	205624 <sup>1</sup>	207528 <sup>1</sup>
		35	3	1.050	1.951 - 2.200	1	10	205629 <sup>1</sup>	207531 <sup>1</sup>
		40	3	1.050	1.951 - 2.200	1	10	205631 <sup>1</sup>	207534 <sup>1</sup>
		45	3	1.050	1.951 - 2.200	1	10	205633 <sup>1</sup>	207537 <sup>1</sup>
		50	3	1.050	1.951 - 2.200	1	10	205635 <sup>1</sup>	207540 <sup>1</sup>
	2450	25	4	1.050	2.201 - 2.450	1	10	205623 <sup>1</sup>	
		30	4	1.050	2.201 - 2.450	1	10	205628 <sup>1</sup>	207529 <sup>1</sup>
		35	4	1.050	2.201 - 2.450	1	10	205630 <sup>1</sup>	207532 <sup>1</sup>
		40	4	1.050	2.201 - 2.450	1	10	205632 <sup>1</sup>	
		45	4	1.050	2.201 - 2.450	1	10	205634 <sup>1</sup>	207538 <sup>1</sup>
		50	4	1.050	2.201 - 2.450	1	10	205636 <sup>1</sup>	207541 <sup>1</sup>

<sup>1</sup> Zkrácení na délku 115 mm a 170 mm. Značka zářezu je na 170 mm.

205670







3.1.5.3 OS-převodovky uzamykatelné zvláštní DM pro PZ variabilní i.S.		L							No	No Tricoat
stříbrné	1750	1.540	25	2	1.251 - 1.750	260	1	10	205670	207542
			30	2	1.251 - 1.750	260	1	10	205671	207543
			35	2	1.251 - 1.750	260	1	10	205672	207545
			40	2	1.251 - 1.750	260	1	10	205673	207547
			45	2	1.251 - 1.750	260	1	10	207316	207549
			50	2	1.251 - 1.750	260	1	10	213074	
	2250	2.040	25	3	1.751 - 2.250	260	1	10	210347	214727
			30	3	1.751 - 2.250	260	1	10	205674	207544
			35	3	1.751 - 2.250	260	1	10	205675	207546
			40	3	1.751 - 2.250	260	1	10	207317	207548
			45	3	1.751 - 2.250	260	1	10	207318	207550
			50	3	1.751 - 2.250	260	1	10	213075	

## 3.2 O-převodovky

### 3.2.1 O-převodovky DM 15







201834

3.2.1.1 O-převodovky DM 15 fix i.S.							N <sup>o</sup>	N <sup>o</sup> Tricoat
stříbrné	430	15	0	125	360 - 430	20	201730 <sup>1</sup>	207448 <sup>1*</sup>
	660	15	0	190	431 - 660	20	201731 <sup>1</sup>	210343 <sup>1*</sup>
	840	15	1	300	661 - 840	20	201833	215752
	1090	15	1	400	841 - 1.090	20	201834	211244
	1340	15	1	500	1.091 - 1.340	10	201835	210073
	1590	15	2	600	1.341 - 1.590	10	201836	
	1700	15	2	700	1.591 - 1.700	10	207302	
	1950	15	3	1.050	1.701 - 1.950	10	201837	211247
	2200	15	3	1.050	1.951 - 2.200	10	201838	210074
	2450	15	4	1.050	2.201 - 2.450	10	201839	210075

<sup>1</sup> Použijte držák štolpu č. 213287 pro montáž.







212121

3.2.1.3 O-převodovky DM 15 fix VZ s KS							N <sup>o</sup>	N <sup>o</sup> Tricoat
stříbrné	430	15	0	125	360 - 430	20	209370 <sup>1</sup>	222657 <sup>1*</sup>
	660	15	0	190	431 - 660	20	209371 <sup>1</sup>	222658 <sup>1*</sup>
	840	15	1	300	661 - 840	20	212119	
	1090	15	1	400	841 - 1.090	20	212121	
	1340	15	1	500	1.091 - 1.340	10	212123	
	1590	15	2	600	1.341 - 1.590	10	212125	
	1700	15	2	700	1.591 - 1.700	10	212127	
	1950	15	3	1.050	1.701 - 1.950	10	212130	
	2200	15	3	1.050	1.951 - 2.200	10	212133	
	2450	15	4	1.050	2.201 - 2.450	10	212136	

<sup>1</sup> Použijte držák štolpu č. 213287 pro montáž.







205547

3.2.1.5 O-převodovky DM 15 fix bez uzavíracích čepů						N <sup>o</sup>	N <sup>o</sup> Tricoat
stříbrné	840	15	300	661 - 840	20	205546	
	1090	15	400	841 - 1.090	20	205547	
	1340	15	500	1.091 - 1.340	10	205548	
	1590	15	600	1.341 - 1.590	10	205549	
	1700	15	700	1.591 - 1.700	10	207304	
	1950	15	1.050	1.701 - 1.950	10	205545	
	2200	15	1.050	1.951 - 2.200	10	205550	
	2450	15	1.050	2.201 - 2.450	10	205551	



202170

3.2.1.6 O-převodovky DM 15 variabilní i.S.		L						N <sup>o</sup>	N <sup>o</sup> Tricoat
stříbrné	800	640	15	0	470 - 800	200	20	201746 <sup>1</sup>	207468 <sup>1*</sup>
	1250	1.040	15	1	801 - 1.250	260	20	202170	
	1350	1.140	15	1	901 - 1.350	260	20	215408	
	1750	1.540	15	2	1.251 - 1.750	260	10	202171	
	2250	2.040	15	3	1.751 - 2.250	260	10	202172	

<sup>1</sup> Použijte držák štolpu č. 213287 pro montáž.



212157



<b>3.2.1.7 O-převodovky DM 15 variabilní VZ</b>		<b>L</b>						<b>No</b>	<b>No</b> Tricoat
stříbrné	800	640	15	0	470 - 800	200	20	<b>201746<sup>1</sup></b>	<b>207468<sup>1*</sup></b>
	1250	1.040	15	1	801 - 1.250	260	20	<b>212157</b>	
	1750	1.540	15	2	1.251 - 1.750	260	10	<b>212159</b>	
	2250	2.040	15	3	1.751 - 2.250	260	10	<b>212161</b>	

<sup>1</sup> Použijte držák štulpu č. 213287 pro montáž.

205542







<b>3.2.1.8 O-převodovky DM 15 variabilní bez uzavíracích čepů</b>		<b>L</b>						<b>No</b>	<b>No</b> Tricoat
stříbrné	1250	1.040	15		801 - 1.250	260	10	<b>205542</b>	<b>211338</b>
	1750	1.540	15		1.251 - 1.750	260	10	<b>205543</b>	<b>211339</b>
	2250	2.040	15		1.751 - 2.250	260	10	<b>205544</b>	<b>211340</b>

### 3.2.2 O-převodovky DM 6,5





202206 

202211 





3.2.2.1 O-převodovky DM 6,5 fix i.S.							No	No Tricoat
stříbrné	660	6,5	0	190	455 - 660	20	202206 <sup>1</sup>	207470 <sup>1</sup>
	840	6,5	1	300	661 - 840	20	202210	
	1090	6,5	1	400	841 - 1.090	20	202211	
	1340	6,5	1	500	1.091 - 1.340	10	202212	
	1590	6,5	2	600	1.341 - 1.590	10	202219	
	1700	6,5	2	700	1.591 - 1.700	10	207306	
	1950	6,5	3	1.050	1.701 - 1.950	10	202220	
	2200	6,5	3	1.050	1.951 - 2.200	10	202221	

<sup>1</sup> Použijte držák štolpu č. 213287 pro montáž.

212060 

3.2.2.3 O-převodovky DM 6,5 fix VZ s KS							No	No Tricoat
stříbrné	840	6,5	1	300	661 - 840	20	212059	
	1090	6,5	1	400	841 - 1.090	20	212060	
	1340	6,5	1	500	1.091 - 1.340	10	212061	
	1590	6,5	2	600	1.341 - 1.590	10	212062	
	1700	6,5	2	700	1.591 - 1.700	10	212063	
	1950	6,5	3	1.050	1.701 - 1.950	10	212064	
	2200	6,5	3	1.050	1.951 - 2.200	10	212065	

202493 

3.2.2.4 O-převodovky DM 6,5 variabilní i.S.		L						No	No Tricoat
stříbrné	800	640	6,5	0	530 - 800	200	20	202491 <sup>1</sup>	207481 <sup>1</sup>
	1250	1.040	6,5	1	801 - 1.250	260	20	202493	
	1750	1.540	6,5	2	1.251 - 1.750	260	10	202495	
	2250	2.040	6,5	3	1.751 - 2.250	260	10	202497	

<sup>1</sup> Použijte držák štolpu č. 213287 pro montáž.

202491 





3.2.2.5 O-převodovky DM 6,5 variabilní VZ		L					No	No Tricoat
stříbrné	800	640	6,5	530 - 800	200	20	202491 <sup>1</sup>	207481 <sup>1</sup>

<sup>1</sup> Použijte držák štolpu č. 213287 pro montáž.

### 3.2.3 O-převodovky zvláštní DM i.S.

209968







3.2.3.1 O-převodovky zvláštní DM fix s navařenými uzávěry						No	No Tricoat
stříbrné	660	30	190	431 - 660	10	224139 <sup>1</sup>	
		50	190	431 - 660	10	218426 <sup>1</sup>	
840	30	300	661 - 840	10	224140		
	50	300	661 - 840	10	218427		
1090	30	400	841 - 1.090	10	224141		
	40	400	841 - 1.090	10	210941		
	50	400	841 - 1.090	10	218428		
1340	30	500	1.091 - 1.340	10	224142		
	40	500	1.091 - 1.340	10	210942		
	50	500	1.091 - 1.340	10	218429		
1590	30	600	1.341 - 1.590	10	224143		
	40	600	1.341 - 1.590	10	211659		
	50	600	1.341 - 1.590	10	218430		
1700	30	700	1.591 - 1.700	10	224144		
	40	700	1.591 - 1.700	10	211660		
	50	700	1.591 - 1.700	10	218431		
1950	30	1.050	1.701 - 1.950	10	209968		
	40	1.050	1.701 - 1.950	10	207014		
	50	1.050	1.701 - 1.950	10	218432		
2200	30	1.050	1.951 - 2.200	10	224145		
	40	1.050	1.951 - 2.200	10	210943		
	50	1.050	1.951 - 2.200	10	218433		
2450	30	1.050	2.201 - 2.450	10	224146		
	40	1.050	2.201 - 2.450	10	210944		

<sup>1</sup> Použijte držák štlupu č. 213287 pro montáž.





218225



3.2.3.2 O-převodovky zvláštní DM variabilní s navařenými uzávěry		L					No	No Tricoat
stříbrné	1250	1.040	50	801 - 1.250	260	10	218225	
	1750	1.540	50	1.251 - 1.750	260	10	218226	
	2250	2.040	50	1.751 - 2.250	260	10	218227	





205515



3.2.3.3 O-převodovky zvláštní DM variabilní i.S.		L						No	No Tricoat
stříbrné	1750	1.540	25	2	1.251 - 1.750	260	10	205515	
			30	2	1.251 - 1.750	260	10	205541	
	2250	2.040	25	3	1.751 - 2.250	260	10	205516	
			30	3	1.751 - 2.250	260	10	205523	

208747



3.2.5 O-převodovky pro oblouková okna i.S.						No	No Tricoat
stříbrné	925	15	3	425 - 925	10	208747	
	1425	15	4	926 - 1.425	10	208748	

### 3.3 Příslušenství převodovek

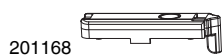

201168

#### 3.3.1 Dveřní západky



No

No  
Tricoat

stříbrné

50

201168

207674\*



44349

#### 3.3.2 Podložky pod dveřní západky



No

No  
Tricoat

RAL 9022 stříbrné pro dveřní západku

3

100

44349

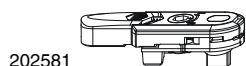

202581

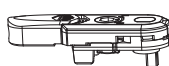

370922

#### 3.3.3 Polohovací pojistky



No

No  
Tricoat

stříbrné

polohovací pojistky dodatečně montovatelné MM

50

202581

215239

polohovací pojistky dodatečně montovatelné MM pro stavěč okna komfort

10

370922



207434



207435

#### 3.3.4 Ochrany převodovky proti odvrtání



No

No  
Tricoat

stříbrné

DM 15 kalené

50

207434<sup>1</sup>

DM 6,5 kalené

50

207435<sup>1</sup>

<sup>1</sup> Použít u oken dle normy EN 1627.



208887

#### 3.3.5 Prodloužení štulpu pro ALU-okna



No

No  
Tricoat

stříbrné

20

208887



213287

#### 3.3.6 Držáky štulpu pro krátké převodovky



No

No  
Tricoat

stříbrné

100

213287



363192



45038



#### 3.3.7 Krytky zámku převodovky



No

No  
Tricoat

Krytky zámku převodovky s logem CE

100

363192<sup>1</sup>

Krytky zámku převodovky s logem MACO

100

45038<sup>1</sup>



<sup>1</sup> Krytky zámku převodovky jsou k dispozici i s logem.



366284 

3.3.8 Prodloužení pro náběh zvedače křídla			No	No Tricoat
stříbrné		100	366284	

366719  366008 





3.3.9 Příslušenství převodovek DM -6				No	No Tricoat
stříbrné	adaptéry pro převodovku DM-6		50	366719	
RAL 9022 stříbrné	mezikusy	1,5	50	366006	
		5	50	367850	
		8,5	50	366007	
		9,5	50	366008	

### 3.4 Hranové závory

#### 3.4.1 Hranové závory DM 15





208328



3.4.1.4 Hranové závory DM 15 středové i.S.						No	No Tricoat
stříbrné	500	15	2	300 - 500	20	<b>208328</b>	<b>216836</b>
	700	15	2	501 - 700	20	<b>208329</b>	<b>210287</b>
	1.000	15	2	701 - 1.000	20	<b>208330</b>	<b>210288</b>
	1.400	15	3	1.001 - 1.400	10	<b>208331</b>	<b>214297</b>
	1.800	15	3	1.401 - 1.800	10	<b>208332</b>	<b>217158</b>
	2.400	15	4	1.801 - 2.400	10	<b>208436</b>	<b>217159</b>

211989







3.4.1.5 Hranové závory DM 15 středové VZ						No	No Tricoat
stříbrné	500	15	2	300 - 500	20	<b>211989</b>	<b>222631</b>
	700	15	2	501 - 700	20	<b>211990</b>	<b>222632</b>
	1.000	15	2	701 - 1.000	20	<b>211991</b>	<b>222811</b>
	1.400	15	3	1.001 - 1.400	10	<b>211992</b>	<b>222812</b>
			4	1.001 - 1.400	10	<b>212694</b>	
	1.800	15	3	1.401 - 1.800	10	<b>211993</b>	<b>222813</b>
2.400	15	4	1.801 - 2.400	10	<b>211994</b>	<b>222814</b>	

#### 3.4.2 Hranové závory DM 6,5

208325







3.4.2.4 Hranové závory DM 6,5 středové i.S.						No	No Tricoat
stříbrné	500	6,5	2	390 - 500	20	<b>208323</b>	
	700	6,5	2	501 - 700	20	<b>208324</b>	
	1.000	6,5	2	701 - 1.000	20	<b>208325</b>	
	1.400	6,5	3	1.001 - 1.400	10	<b>208326</b>	
	1.800	6,5	3	1.401 - 1.800	10	<b>208327</b>	



### 3.4.3 Hranové závory s namontovanými sklopnými nůžkami

206268 





3.4.3.1 Hranové závory středové i.S. s namontovanými sklopnými nůžkami					No	No Tricoat
stříbrné						

<sup>1</sup> Předmontované sklopné nůžky

<sup>2</sup> Ručení za výrobek předepisuje přídatné použití záchytných nůžek. Maximální hmotnost křídla dle parametrů záchytných nůžek.

<sup>3</sup> Dvoje předmontované sklopné nůžky.

212702 





3.4.3.2 Hranové závory středové VZ s namontovanými sklopnými nůžkami					No	No Tricoat
stříbrné						

<sup>1</sup> Předmontované sklopné nůžky.

<sup>2</sup> Ručení za výrobek předepisuje přídatné použití záchytných nůžek. Maximální hmotnost křídla dle parametrů záchytných nůžek.

<sup>3</sup> Dvoje předmontované sklopné nůžky.

206174 

3.4.3.3 Hranové závory variabilní i.S. s namontovanými sklopnými nůžkami					No	No Tricoat
stříbrné						

<sup>1</sup> Předmontované sklopné nůžky.

<sup>2</sup> Ručení za výrobek předepisuje přídatné použití záchytných nůžek. Maximální hmotnost křídla dle parametrů záchytných nůžek.



<sup>3</sup> Dvoje předmontované sklopné nůžky.

94074 

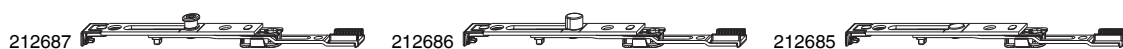

3.4.3.4 Držák štulpu pro hranovou závoru		No	No Tricoat
stříbrné			

### 3.5 Ukončení



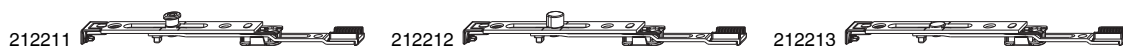

3.5.1 Ukončení mit 90° (O)					N <sup>o</sup>	N <sup>o</sup> Tricoat
stříbrné	90° horní s 1 i.S.	0	1	20	<b>212687</b>	<b>222999*</b>
	90° horní s 1 VZ	1	0	20	<b>212686</b>	
	90° horní bez čepů	0	0	20	<b>212685</b>	





3.5.2 Ukončení s 180° (OS, štulpové)					N <sup>o</sup>	N <sup>o</sup> Tricoat
stříbrné	180° spodní a horní s 1 i.S.	0	1	20	<b>212211</b>	<b>222927</b>
	180° spodní a horní s 1 VZ	1	0	20	<b>212212</b>	
	180° spodní a horní bez čepů	0	0	20	<b>212213</b>	<b>222929</b>





3.5.3 Ukončení horní pro oblouková okna					N <sup>o</sup>	N <sup>o</sup> Tricoat
stříbrné	horní s 1 i.S.	450 - 1.000	1	20	<b>205177<sup>1</sup></b>	<b>207556<sup>1</sup></b>
	zakratitelné 1090/600 horní s 3i.S.	671 - 1.250	3	10	<b>209033<sup>1</sup></b>	
	pro otevíravá okna horní s 2i.S.	671 - 1.250	2	10	<b>212963<sup>1</sup></b>	<b>223014<sup>1</sup></b>

<sup>1</sup> Použití možné pouze pro 1-kř. okna.



3.5.4 Sklopné ukončení pro převodovky				N <sup>o</sup>	N <sup>o</sup> Tricoat
stříbrné	s KS pro okna spodní	470 - 1.750	20	<b>212689</b>	<b>223001*</b>
	s KS pro dveře spodní	1.751 - 2.250	20	<b>212688</b>	<b>223000</b>





3.5.5 Ukončení spodní EH					N <sup>o</sup>	N <sup>o</sup> Tricoat
stříbrné	spodní s 1i.S.	1.340 - 2.450	1	20	<b>205644<sup>1</sup></b>	<b>207558<sup>1*</sup></b>
	s KS pro dveře spodní	1.701 - 2.450	0	20	<b>203744<sup>2</sup></b>	<b>207560<sup>2</sup></b>

<sup>1</sup> Použit u oken dle normy EN 1627.



<sup>2</sup> Použit u převodovek s ryskou pro zakřácení 170 mm.



3.5.6 Ukončení spodní pro otevíravá okna protiběžné				N <sup>o</sup>	N <sup>o</sup> Tricoat
stříbrné		500 - 2.350	20	<b>225092</b>	

\* TRICOAT-PLUS-Standardartikel









208432  214014  214015  214016 

<b>3.5.7 Ukončení horní pro protiběžné hranové závory</b>				<b>No</b>	<b>No</b> Tricoat
stříbrné	pro hranovou závoru protiběžnou horní s výsuv.trnem	431 - 2.450	20	<b>208432</b>	<b>222624*</b>
	pro hranovou závoru protiběžnou horní s prodlužitelným ukončení s výsuv.trnem jednostr. šikm.	431 - 2.450	100	<b>214013</b>	
	pro hranovou závoru protiběžnou horní s prodlužitelným ukončení s výsuv.trnem oboustr. šikm.	431 - 2.450	100	<b>214014</b>	
	pro hranovou závoru s protiběžnou převodovkou horní s prodlužitelným ukončení s výsuv.trnem	431 - 2.450	100	<b>214015</b>	
	pro hranovou závoru protiběžnou horní s prodlužitelným ukončení s výsuv.trnem	431 - 2.450	20	<b>214016</b>	<b>223046</b>
	pro hran.závoru protiběž. prodl. horní s prodlužitelným ukončení s výsuv.trnem jednostr. šikm.pravé	431 - 2.450	100	<b>218977</b>	
	pro hran.závoru protiběž. prodl. horní s prodlužitelným ukončení s výsuv.trnem jednostr. šikm.levé	431 - 2.450	100	<b>218978</b>	

### 3.6 Dveřní balkonové závory B-TV



203696

3.6.2 Dveřní balkonové závory B-TV E92 s PZ		L								
stříbrné	fix s 2 i.S. čepy	1.347	25	8	1.050	92	5	<b>203828</b>		
			28	8	1.050	92	5	<b>203696</b>		
			35	8	1.050	92	5	<b>203829</b>		
			40	8	1.050	92	5	<b>203830</b>		
			45	8	1.050	92	5	<b>203831</b>		
			50	8	1.050	92	5	<b>203832</b>		
			55	8	1.050	92	5	<b>203833</b>		



## 4 Rohové převody

---

- 4.1 **Rohové převody i.S.** \_\_\_\_\_
- 4.1.1 Rohové převody Standard i.S.
- 4.1.2 Rohové převody vodorovné i.S.
- 4.1.3 Rohové převody svislé i.S.
- 4.2 **Rohové převody VZ** \_\_\_\_\_
- 4.3 **Rohové převody i.S. pro variabilní převodovky** \_\_\_\_\_
- 4.4 **Rohové převody i.S. pro štulpové převodovky** \_\_\_\_\_
- 4.5 **Rohové převody i.S. pro šikmá okna** \_\_\_\_\_
- 4.6 **Rohové převody i.S. pro oblouková okna** \_\_\_\_\_
- 4.7 **Rohové převody pro práh 14 mm L** \_\_\_\_\_
- 4.8 **Rohové převody pro práh 18 mm L** \_\_\_\_\_
- 4.9 **Příslušenství rohových převodů** \_\_\_\_\_
- 4.9.1 Omezovače pohybu kování
- 4.9.2 Šrouby se zapuštěnou hlavou M4x8 pro rohové převody krátké MM
- 4.9.3 Držáky štulpu MM
- 4.9.4 Adaptéry rovný stříh MM/opravné díly
- 4.9.5 Kryty štulpu MM
- 4.9.6 Krytky řezu MM
- 4.9.7 Spojovací plíšky MM EH
- 4.9.8 Násuvné díly pro rohové převody MM jako pojistka pro 3kř. elementy
- 4.9.9 Překryvné folie pro rohový převod šikmých oken
- 4.9.10 Náběhy pro rohový převod vodorovný MM
- 4.9.11 Podložka pro zubovou vaničku

## 4 Rohové převody

### 4.1 Rohové převody i.S.

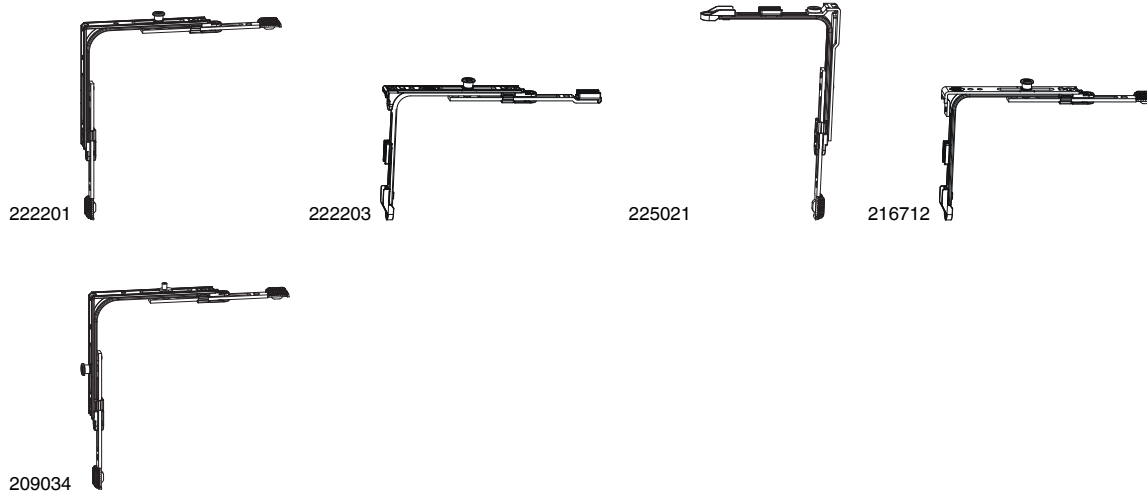

4.1.1 Rohové převody Standard i.S.					No	No Tricoat
stříbrné	s 1 i.S.	320 - 1.800	360 - 2.800	50	<b>222201</b>	<b>207564*</b>
	s 2 i.S.	320 - 1.800	360 - 2.800	50	<b>222202</b>	<b>207567*</b>
	krátké s 1 i.S.	220 - 319	275 - 359	50	<b>222203<sup>1</sup></b>	<b>207566<sup>2*</sup></b>
	krátké s výsuvným trnem a prošroubováním štlupu	225 - 319	275 - 359	50	<b>225021<sup>3,4</sup></b>	
	krátké s prošroubováním štlupu s 1i.S.	225 - 324	280 - 364	50	<b>216712<sup>5</sup></b>	<b>218976<sup>5</sup></b>
	pro spár.větr. s 1i.S.	320 - 1.800	360 - 2.800	50	<b>209034</b>	
	s 5 polohami větrání s 1i.S. pro otevíravá okna s 1i.S.	400 - 1.000 320 - 1.800	800 - 1.700 360 - 2.800	30 50	<b>101879<sup>6</sup></b> <b>209610</b>	<b>103777<sup>6*</sup></b> <b>218078</b>

<sup>1</sup> Šrouby se zapuštěnou hlavou M4x8 mm, Art. Nr. 101339 přibaleny.

<sup>2</sup> Šrouby se zapuštěnou hlavou M4x8 mm, Art. Nr. 101683 přibaleny.

<sup>3</sup> Šrouby se zapuštěnou hlavou M4x6 mm Art. Nr. 104548 přibaleny.

<sup>4</sup> Použitelné jen ve spojení s OS převodovkou s KS

<sup>5</sup> Šrouby se zapuštěnou hlavou M4x6 mm, Art. Nr. 101617 přibaleny.

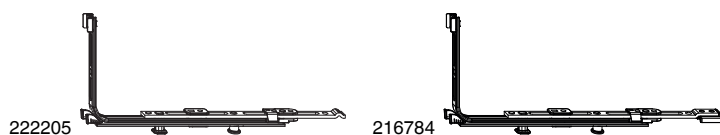

<sup>6</sup> V případě dřeva dbejte na hloubku falcu!





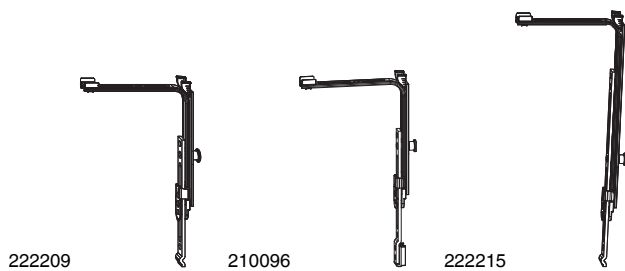

4.1.2 Rohové převody vodorovné i.S.				No	No Tricoat
stříbrné	vodorovné s 1 i.S.	320 - 750	50	<b>222204<sup>1</sup></b>	
	vodorovné prodlužitelné s 1 i.S.	320 - 1.800	50	<b>222205<sup>1</sup></b>	<b>207569<sup>1*</sup></b>
	se zub.spoj. vodorovné prodlužitelné s 1 i.S.	320 - 1.800	50	<b>216784<sup>1</sup></b>	<b>219370<sup>1</sup></b>

<sup>1</sup> V kombinaci s falc.křídíl.dílem možno použít od FFB 365 mm.

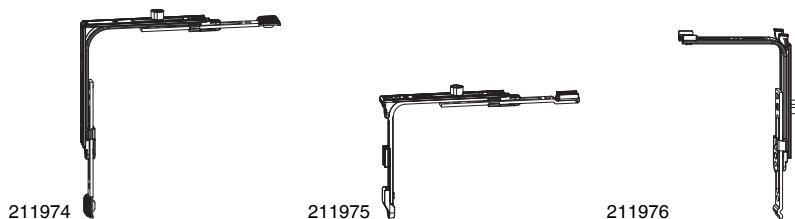

4.1.3 Rohové převody svislé i.S.				<b>No</b>	<b>No</b> Tricoat
stříbrné	svislé s 1 i.S.	470 - 750	50	<b>222208</b>	<b>218232</b>
	svislé prodlužitelné s 1 i.S.	750 - 2.800	50	<b>222209</b>	<b>207575*</b>
	svislé prodlužitelné bez i.S. čepů	750 - 2.800	50	<b>222214</b>	<b>209792*</b>
	se zub.spoj. svislé prodlužitelné s 1 i.S.	750 - 2.800	10	<b>210096</b>	<b>211241</b>
	s pozicí čepu 137 mm svislé prodlužitelné s 1 i.S.	750 - 2.800	50	<b>222215</b>	<b>207576*</b>



4.2 Rohové převody VZ					<b>No</b>	<b>No</b> Tricoat
stříbrné	s 1 VZ	320 - 1.800	360 - 2.800	50	<b>211974</b>	
	krátké s 1 VZ	220 - 319	275 - 359	50	<b>211975<sup>1</sup></b>	
	svislé prodlužitelné s 1 VZ	320 - 1.800	750 - 2.800	50	<b>211976</b>	
	pro spár.větr. s 1 VZ	320 - 1.800	360 - 2.800	50	<b>228430</b>	
	s 5 polohami větrání s 1 VZ	400 - 1.000	800 - 1.700	30	<b>105309<sup>2</sup></b>	

<sup>1</sup> Šrouby se zapuštěnou hlavou M4x8 mm, Art. Nr. 101339 přibaleny.

<sup>2</sup> V případě dřeva dbejte na hloubku falcu!

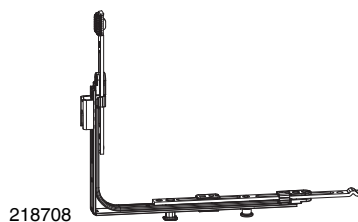
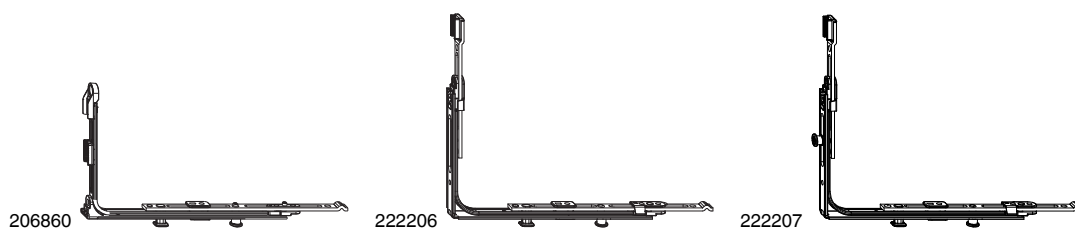

### 4.3 Rohové převody i.S. pro variabilní převodovky



**No**

**No**  
Tricoat

stříbrné	krátké pro variabilní převodovku vodorovné prodlužitelné s 1 i.S.	320 - 1.800	250 - 650	50	<b>206860</b> <sup>1,2</sup>	<b>207572</b> <sup>1,3</sup>
	pro variabilní převodovku vodorovné prodlužitelné s 1 i.S.	320 - 1.800	470 - 2.800	50	<b>222206</b> <sup>1</sup>	<b>207570</b> <sup>1*</sup>
	pro variabilní převodovku vodorovné prodlužitelné s 2 i.S.	320 - 1.800	470 - 2.800	50	<b>222207</b> <sup>1</sup>	<b>207571</b> <sup>1*</sup>
	pro variabilní převodovku pro SO vodorovné prodlužitelné s 2 i.S.	320 - 1.800	470 - 2.800	50	<b>211934</b> <sup>1</sup>	
	pro variabilní převodovku vodorovné prodlužitelné s 1 i.S. a uzávěrem	320 - 1.800	470 - 2.800	50	<b>218708</b> <sup>1</sup>	

<sup>1</sup> V kombinaci s falc.křídíl.dílem možno použít od FFB 365 mm.

<sup>2</sup> Šrouby se zapuštěnou hlavou M4x8 mm, Art. Nr. 101339 přibaleny.

<sup>3</sup> Šrouby se zapuštěnou hlavou M4x8 mm, Art. Nr. 101683 přibaleny.



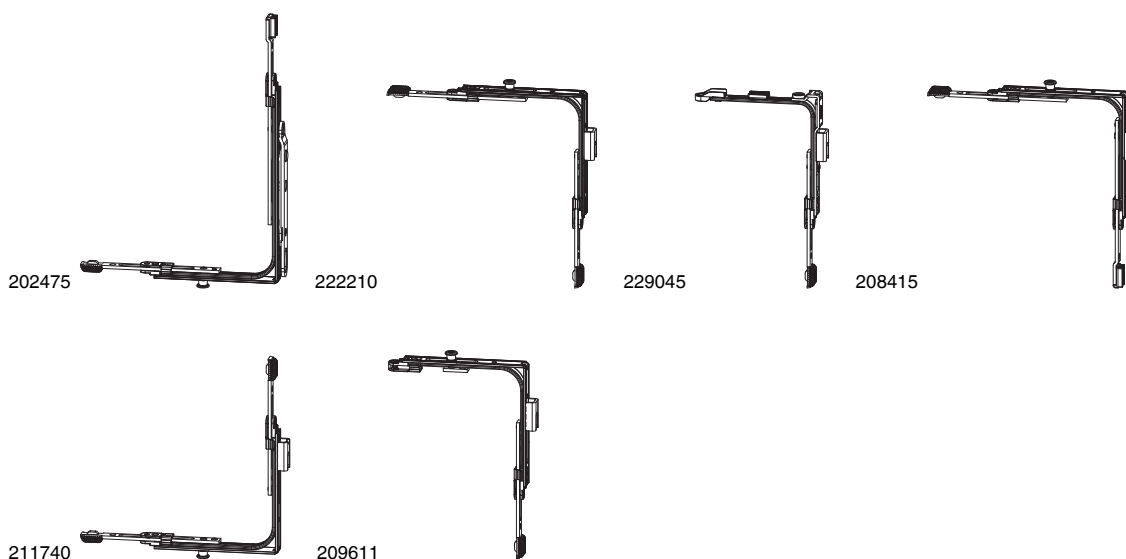

#### 4.4 Rohové převody i.S. pro štlupové převodovky

				<b>No</b>	<b>No</b> Tricoat	
stříbrné	variabilní 1250 skryté s 1i.S.	801 - 1.250	10	<b>205973</b> <sup>1</sup>		
	variabilní 1250 s pákou s 1i.S.	801 - 1.250	10	<b>202475</b> <sup>2</sup>	<b>207578</b> <sup>2</sup>	
	2kř. s 1i.S. a uzávěrem	320 - 1.800	360 - 2.800	20	<b>222210</b>	<b>207565</b> *
	2kř. krátké s výsuvným trnem a uzávěrem	225 - 319	275 - 359	50	<b>229045</b> <sup>3</sup>	
	2kř. RC2 s posuvnou západkou s 1i.S.	320 - 1.800	360 - 2.800	20	<b>208415</b> <sup>4</sup>	<b>214184</b> *
	2kř. RC2 s uzávěrem spodním	320 - 1.800	841 - 2.800	50	<b>211740</b>	<b>214185</b>
	2kř. pro otevírávací okna s 1i.S. a uzávěrem	320 - 1.800	360 - 2.800	20	<b>209611</b>	<b>216970</b>

<sup>1</sup> Pro štlupovou převodovku 1250 variabilní pro meziprofil (Art. Nr. 205970)!

<sup>2</sup> Pro štlupovou převodovku 1250 variabilní (Art. Nr. 202471)!

<sup>3</sup> Použitelné jen ve spojení se štlupovou převodovkou s KS.



<sup>4</sup> Použit u oken dle normy EN 1627



#### 4.5 Rohové převody i.S. pro šikmá okna



			<b>No</b>	<b>No</b> Tricoat	
stříbrné	s 1 i.S.	440 - 1.300	20	<b>222212</b>	<b>207568</b>
	s 2 i.S.	440 - 1.300	20	<b>214990</b>	<b>217161</b>
	krátké s 1 i.S.	330 - 1.300	50	<b>209655</b>	<b>217160</b>

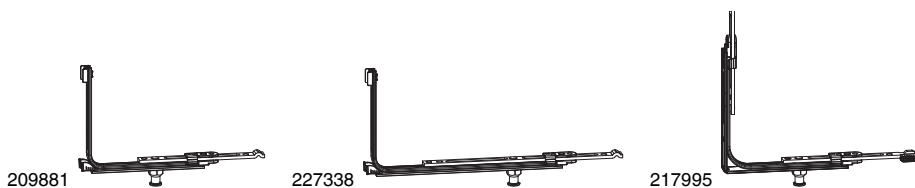

4.6 Rohové převody i.S. pro oblouková okna					No	No Tricoat
stříbrné	vodorovné prodlužitelné s 1 i.S.		450 - 1.300	10	<b>222211<sup>1</sup></b>	<b>207573<sup>1</sup></b>
	pro KS vodorovné prodlužitelné bez čepů		450 - 1.300	10	<b>215216<sup>1</sup></b>	
	4L vodorovné prodlužitelné s 1i.S.		450 - 1.300	10	<b>218072<sup>1</sup></b>	
	pro variabilní převodovku vodorovné prodlužitelné s 2i.S.		450 - 1.300	10	<b>222213<sup>1</sup></b>	<b>207574<sup>1</sup></b>
	pro variabilní převodovku 4L vodorovné prodlužitelné s 2i.S.		450 - 1.300	10	<b>218071<sup>1</sup></b>	

<sup>1</sup> Pro FFB do 380 mm použít rohový převod krátký a spodní pant rámový PVC.



4.8 Rohové převody pro práh 18 mm L						No	No Tricoat
stříbrné	Rohové převody MM pro práh	pro 18 mm L	260 - 1.800		50	<b>209881</b>	<b>211722*</b>
	Rohové převody MM pro práh pro EH	pro 18 mm L	320 - 1.800		50	<b>227338</b>	
	Rohové převody MM pro práh pro variabilní převodovku	s dlouhými čepy 18L	260 - 1.800	360 - 2.800	50	<b>217995</b>	
		s dlouhými čepy 18L a 1 i.S.	260 - 1.800	360 - 2.800	50	<b>226694</b>	
		s dlouhými čepy 18L a uzávěrem	260 - 1.800	360 - 2.800	50	<b>226695</b>	

## 4.9 Příslušenství rohových převodů

357081  355418  43625 

4.9.1 Omezovače pohybu kování			No	No Tricoat
stříbrné	omezovače pohybu 90° k našroubování	200	357081 <sup>1</sup>	357887 <sup>1*</sup>
bílé	omezovače pohybu 90° MM k naklapnutí z PVC	200	355418 <sup>1</sup>	
	omezovače pohybu k našroubování z PVC 90° k našroubování	200	43625 <sup>1</sup>	

<sup>1</sup> Dodávky také pod balicím množstvím.

101339 

4.9.2 šrouby se zapuštěnou hlavou M4x8 pro rohové převody krátké MM		L		No	No Tricoat
stříbrné		8	50	101339	101683

355678 

4.9.3 Držáky štulpu MM			No	No Tricoat
stříbrné		100	355678 <sup>1</sup>	

<sup>1</sup> Dodávky také pod balicím množstvím.

352980 

4.9.4 Adaptéry rovný stříh MM/opravné díly			No	No Tricoat
stříbrné		100	352980 <sup>1,2</sup>	357877 <sup>1,2*</sup>

<sup>1</sup> Dodávky také pod balicím množstvím.

<sup>2</sup> Není zámkové spojení.

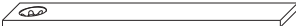
357960 

4.9.5 Kryty štulpu MM		L		No	No Tricoat
stříbrné		90	100	357960	364410

354966 

4.9.6 Krytky řezu MM			No	No Tricoat
stříbrné		100	354966	
	s potiskem MACO 2-barevný	100	357252	

358368 

<b>4.9.7 Spojovací plíšky MM EH</b>		<b>No</b>	<b>No</b> Tricoat
stříbrné	100	<b>358368<sup>1</sup></b>	<b>385036<sup>1</sup></b>

<sup>1</sup> Použít u oken dle normy EN 1627.

363796 

<b>4.9.8 Násuvné díly pro rohové převody MM jako pojistka pro 3kř. elementy</b>		<b>No</b>	<b>No</b> Tricoat
stříbrné	50	<b>363796</b>	

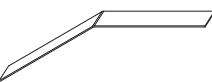
104256 

<b>4.9.9 Překryvné folie pro rohový převod šikmých oken</b>		<b>No</b>	<b>No</b> Tricoat
stříbrné	100	<b>104256</b>	

366348 

<b>4.9.10 Náběhy pro rohový převod vodorovný MM</b>		<b>No</b>	<b>No</b> Tricoat
bílé	100	<b>366348</b>	

44273 

<b>4.9.11 Podložka pro zubovou vaničku</b>		<b>No</b>	<b>No</b> Tricoat
bílé	200	<b>44273</b>	





## 5 Střední závory / Vodorovné sklopné díly / Prodloužení štulpu

---

- 5.1 Střední závory fix i.S. \_\_\_\_\_
- 5.2 Střední závory prodlužitelné i.S. \_\_\_\_\_
- 5.3 Střední závory prodlužitelné VZ \_\_\_\_\_
- 5.4 Střední závory protiběžné i.S. \_\_\_\_\_
- 5.5 Střední závory jednodílné i.S. \_\_\_\_\_
- 5.6 Střední závory jednodílné VZ \_\_\_\_\_
- 5.7 Střední závory jednodílné EH \_\_\_\_\_
- 5.8 Sklopné díly jednodílné i.S. \_\_\_\_\_
- 5.9 Sklopné díly jednodílné EH \_\_\_\_\_
- 5.10 Prodloužení štulpu fix a prodlužitelné \_\_\_\_\_
- 5.11 Prodloužení štulpu zakratitelné MM \_\_\_\_\_
- 5.12 Prodloužení štulpu zakratitelné MM B-TV \_\_\_\_\_
- 5.13 Prodloužení štulpu pro práh 14 mm L \_\_\_\_\_
- 5.14 Střední závory pro práh 14 mm L \_\_\_\_\_
- 5.15 Prodloužení štulpu pro práh 18 mm L \_\_\_\_\_
- 5.16 Střední závory pro práh 18 mm L \_\_\_\_\_
- 5.17 Hákový uzávěr vodorovný prodlužitelný \_\_\_\_\_
- 5.18 Výškové díly SKB S-SE \_\_\_\_\_
- 5.19 Šířkové díly SKB S-SE \_\_\_\_\_



## 5 Střední závory / Vodorovné sklopné díly / Prodloužení štlpu

201751 

5.1 Střední závory fix i.S.				L			N <sup>o</sup>	N <sup>o</sup> Tricoat
stříbrné	1280	s 1 i.S.	1	470	801 - 1.280	20	201751	209781*
	1500	s 1 i.S.	1	705	1.281 - 1.500	20	201752	209782*

201840 

201754 

5.2 Střední závory prodlužitelné i.S.				L			N <sup>o</sup>	N <sup>o</sup> Tricoat
stříbrné	1280V	s 1 i.S.	1	470	801 - 1.280	20	201840 <sup>1</sup>	207446 <sup>1</sup> *
	1500V	s 1 i.S.	1	705	1.281 - 1.500	20	201753	207447*
	V rozsahu 1501 - 1700 mm použít obj. č. 201753 a 201840.							
	2200V	s 2 i.S.	2	1.410	1.701 - 2.200	10	201754	209783*

<sup>1</sup> Při použití falc.křídíl.dílů možno od FFH/FFB 850 mm!

215272 

5.3 Střední závory prodlužitelné VZ				L			N <sup>o</sup>	N <sup>o</sup> Tricoat
stříbrné	1280V	s 1 VZ	1	470	801 - 1.280	20	215272 <sup>1</sup>	

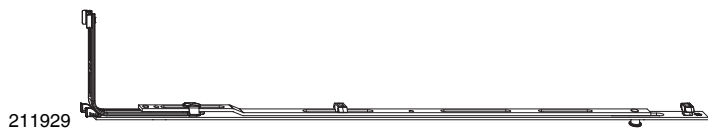

<sup>1</sup> Při použití falc.křídíl.dílů možno od FFH/FFB 850 mm!



211929



211932

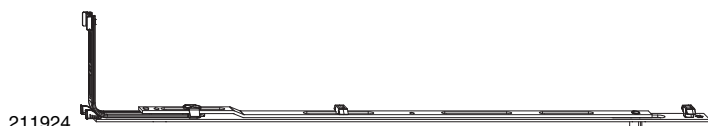

<b>5.5 Střední závory jednodílné i.S.</b>						<b>No</b>	<b>No</b> Tricoat
stříbrné	700	s 1 i.S.	1	480 - 700	20	<b>218493</b>	
V rozsahu 701 - 800 mm použít obj. č. 215449 (střední závora jednodílná Gr. 840).*							
	1280	s 1 i.S.	1	801 - 1.280	20	<b>211929</b>	<b>222786*</b>
	1500	s 1 i.S.	1	1.281 - 1.500	20	<b>211930</b>	<b>222787*</b>
		s 2 i.S.	2	1.281 - 1.500	20	<b>215696</b>	<b>218777</b>
	2000	s 2 i.S.	2	1.501 - 2.000	10	<b>211931</b>	<b>222788*</b>
	2200V	s 2 i.S.	2	2.001 - 2.200	10	<b>211932</b>	<b>222789*</b>
	2450	s 3 i.S.	3	2.201 - 2.450	10	<b>211933</b>	<b>222790*</b>

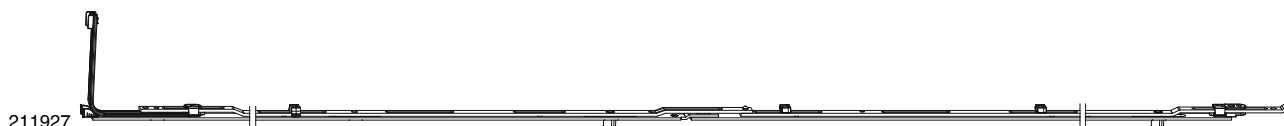

211924



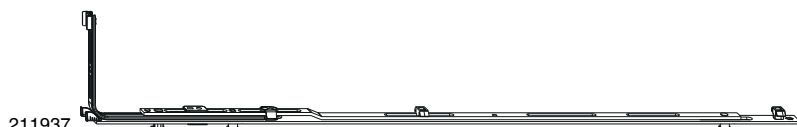

211927

<b>5.6 Střední závory jednodílné VZ</b>						<b>No</b>	<b>No</b> Tricoat
stříbrné	700	s 1 VZ	1	480 - 700	20	<b>228398</b>	
	1280	s 1 VZ	1	801 - 1.280	20	<b>211924</b>	
	1500	s 1 VZ	1	1.281 - 1.500	20	<b>211925</b>	
	2000	s 2 VZ	2	1.501 - 2.000	10	<b>211926</b>	
	2200V	s 2 VZ	2	2.001 - 2.200	10	<b>211927</b>	
	2450	s 3 VZ	3	2.201 - 2.450	10	<b>211928</b>	







211937





<b>5.8 Sklopné díly jednodílné i.S.</b>						<b>No</b>	<b>No</b> Tricoat
stříbrné	1280	s 2 i.S.	2	801 - 1.280	20	<b>211937</b>	<b>222791*</b>
	1500	s 2 i.S.	2	1.281 - 1.500	20	<b>211938</b>	<b>222792*</b>

210496  201841  212214 

217866 

5.10 Prodloužení štlpu fix a prodlužitelné				L			 Tricoat
stříbrné	prodloužení štlpu fix MM	s 1 i.S.	1	235	20	<b>210496</b>	<b>218772</b>
		s 2 i.S.	2	235	20	<b>214547</b>	
stříbrné	prodloužení štlpu prodlužitelné MM		0	138,5	20	<b>206630</b>	<b>207443*</b>
		s 1 i.S.	1	138,5	20	<b>201841</b>	<b>207442*</b>
			0	235	20	<b>206197</b>	<b>207445*</b>
		s 1 i.S.	1	235	20	<b>201750</b>	<b>207444*</b>
		s 2 i.S.	2	235	20	<b>214546</b>	
		s zvedačem křídla	0	235	20	<b>212214</b>	
		s klínem pravé	0	235	20	<b>217865</b>	
s klínem levé	0	235	20	<b>217866</b>			

203697 



5.12 Prodloužení štlpu zakratitelné MM B-TV				L				 Tricoat
stříbrné	1950	s 1 i.S.	1	497	260	10	<b>203697</b>	
	2200	s 1 i.S.	1	747	260	10	<b>203698</b>	
	2450	s 2 i.S.	2	997	260	10	<b>203699</b>	





214848 

5.15 Prodloužení štlpu pro práh 18 mm L		L		No	No Tricoat
stříbrné	prodloužení štlpu prodlužitelné MM 235	235	10	<b>214848</b>	



209882 

5.16 Střední závory pro práh 18 mm L				No	No Tricoat
stříbrné	střední závory prodlužitelné MM 1280V	801 - 1.280	10	<b>209882</b>	<b>211723</b>
	střední závory prodlužitelné MM 1500V	1.281 - 1.500	10	<b>209883</b>	



228710 

5.17 Hákový uzávěr vodorovný prodlužitelný		L			No	No Tricoat
stříbrné	pro 7,5 mm vůli ve falcu	349	540 - 1.800	10	<b>228710</b>	
	pro 10 mm vůli ve falcu	349	540 - 1.800	10	<b>229814</b>	

210335 

5.18 Výškové díly SKB S-SE				No	No Tricoat	
stříbrné	s 1 i.S.	1090	841 - 1.090	10	<b>210335</b>	<b>211234</b>
		1340	1.091 - 1.340	10	<b>210336</b>	<b>211235</b>
	s 2 i.S.	1590	1.341 - 1.590	10	<b>210337</b>	<b>211236</b>
		1700	1.591 - 1.700	10	<b>210338</b>	<b>211237</b>
	s 3 i.S.	1950	1.701 - 1.950	10	<b>210339</b>	<b>211238</b>
		2200	1.951 - 2.200	10	<b>210340</b>	<b>211239</b>
	s 4 i.S.	2450	2.201 - 2.450	10	<b>210341</b>	<b>211240</b>

210380 

5.19 Šířkové díly SKB S-SE				No	No Tricoat	
stříbrné	s 1 i.S.	900	620 - 900	20	<b>210380</b>	<b>211229</b>
		1150	901 - 1.150	20	<b>210381</b>	<b>211231</b>
		1400	1.151 - 1.400	20	<b>210382</b>	<b>211232</b>
	s 2 i.S.	1650	1.401 - 1.650	10	<b>210383</b>	<b>211233</b>

**MACO**  
**MULTI-MATIC**



Střední závory / Vodorovné sklopné díly  
/ Prodloužení štulpu



## 6 Nůžky

---





- 6.1 Úhelníkové nůžky \_\_\_\_\_
- 6.2 Úhelníkové nůžky MULTI MAMMUT \_\_\_\_\_
- 6.3 Nůžky TV \_\_\_\_\_
- 6.4 Nůžky INVISIBLE \_\_\_\_\_
- 6.5 Nůžky MULTI POWER \_\_\_\_\_
- 6.6 Nůžky Komfort \_\_\_\_\_
- 6.7 Sklopné nůžky \_\_\_\_\_
- 6.8 Nůžky pro nadsvětlíky \_\_\_\_\_
- 6.9 Záchytné nůžky \_\_\_\_\_
- 6.10 Příslušenství nůžek \_\_\_\_\_

## 6 Nůžky

### 6.1 Úhelníkové nůžky

211904







6.1.7 Úhelníkové nůžky i.S.						N <sup>o</sup>	N <sup>o</sup> Tricoat	
stříbrné	Nůžky smontované MM	400	0	320 - 400	220 - 320	20	<b>211694</b>	<b>222727*</b>
		600	0	401 - 600	321 - 490	20	<b>211695</b>	<b>222728*</b>
		800	0	601 - 800	491 - 690	20	<b>211696</b>	<b>222729*</b>
			1	630 - 800		20	<b>211904</b>	<b>222772*</b>
		1050	1	801 - 1.050		20	<b>211905<sup>1</sup></b>	<b>222773<sup>1*</sup></b>
		1300	1	1.051 - 1.300		20	<b>211906<sup>1</sup></b>	<b>222774<sup>1*</sup></b>

<sup>1</sup> Od FFB 1301 mm je předepsáno použití druhých nůžek.

211697







6.1.8 Úhelníkové nůžky VZ						N <sup>o</sup>	N <sup>o</sup> Tricoat	
stříbrné	Nůžky smontované MM	400	0	320 - 400	220 - 320	20	<b>211694</b>	<b>222727*</b>
		600	0	401 - 600	321 - 490	20	<b>211695</b>	<b>222728*</b>
		800	0	601 - 800	491 - 690	20	<b>211696</b>	<b>222729*</b>
			1	630 - 800		20	<b>211697</b>	
		1050	1	801 - 1.050		20	<b>211698<sup>1</sup></b>	
		1300	1	1.051 - 1.300		20	<b>211699<sup>1</sup></b>	

<sup>1</sup> Od FFB 1301 mm je předepsáno použití druhých nůžek.

211898







6.1.9 Úhelníkové nůžky i.S. pro spárové větrání							N <sup>o</sup>	N <sup>o</sup> Tricoat	
stříbrné	pravé	Nůžky smontované MM	400	0	320 - 400	220 - 320	20	<b>211673<sup>1</sup></b>	<b>222715<sup>1*</sup></b>
			600	0	401 - 600	321 - 490	20	<b>211675<sup>1</sup></b>	<b>222717<sup>1*</sup></b>
			800	0	601 - 800	491 - 690	20	<b>211677<sup>1</sup></b>	<b>222719<sup>1*</sup></b>
				1	630 - 800		20	<b>211898<sup>1</sup></b>	
			1050	1	801 - 1.050		20	<b>211900<sup>1,2</sup></b>	<b>222768<sup>1,2*</sup></b>
	1300	1	1.051 - 1.300		20	<b>211902<sup>1,2</sup></b>	<b>222770<sup>1,2</sup></b>		
	levé	Nůžky smontované MM	400	0	320 - 400	220 - 320	20	<b>211674<sup>1</sup></b>	<b>222716<sup>1*</sup></b>
			600	0	401 - 600	321 - 490	20	<b>211676<sup>1</sup></b>	<b>222718<sup>1*</sup></b>
			800	0	601 - 800	491 - 690	20	<b>211678<sup>1</sup></b>	<b>222720<sup>1*</sup></b>
				1	630 - 800		20	<b>211899<sup>1</sup></b>	
1050			1	801 - 1.050		20	<b>211901<sup>1,2</sup></b>	<b>222769<sup>1,2*</sup></b>	
1300	1	1.051 - 1.300		20	<b>211903<sup>1,2</sup></b>	<b>222771<sup>1,2</sup></b>			

<sup>1</sup> Používejte pouze ve spojení s "horizontálním sklopním dílem" (s "vertikálním sklopním dílem" lze křídlo vyklopit ven z uzávěru).

<sup>2</sup> Od FFB 1301 mm je předepsáno použití druhých nůžek.

211679







6.1.10 Úhelníkové nůžky VZ pro spárové větrání							No	No Tricoat		
stříbrné	pravé	Nůžky smontované MM	400	0	320 - 400	220 - 320	20	211673 <sup>1</sup>	222715 <sup>1*</sup>	
			600	0	401 - 600	321 - 490	20	211675 <sup>1</sup>	222717 <sup>1*</sup>	
			800	0	601 - 800	491 - 690	20	211677 <sup>1</sup>	222719 <sup>1*</sup>	
				1	630 - 800		20	211679 <sup>1</sup>		
				1050	1	801 - 1.050		20	211681 <sup>1,2</sup>	
				1300	1	1.051 - 1.300		20	211683 <sup>1,2</sup>	
	levé	Nůžky smontované MM	400	0	320 - 400	220 - 320	20	211674 <sup>1</sup>	222716 <sup>1*</sup>	
			600	0	401 - 600	321 - 490	20	211676 <sup>1</sup>	222718 <sup>1*</sup>	
			800	0	601 - 800	491 - 690	20	211678 <sup>1</sup>	222720 <sup>1*</sup>	
				1	630 - 800		20	211680 <sup>1</sup>		
				1050	1	801 - 1.050		20	211682 <sup>1,2</sup>	
				1300	1	1.051 - 1.300		20	211684 <sup>1,2</sup>	

<sup>1</sup> Používejte pouze ve spojení s "horizontálním sklopním dílem" (s "vertikálním sklopným dílem" lze křídlo vykloupat ven z uzávěru).

<sup>2</sup> Od FFB 1301 mm je předepsáno použití druhých nůžek.





202318



6.1.11 Úhelníkové nůžky pro šikmá okna i.S.							No	No Tricoat
stříbrné	630	0	430 - 630	80	10		202316	207622
	800	0	500 - 800	80	10		202317	207623
		1	631 - 800	80	10		208892	
	1050	1	801 - 1.050	80	10		202318	207624
	1300	1	1.051 - 1.300	80	10		202319	207625

207621



6.1.12 Úhelníkové nůžky pro oblouková okna i.S.			L						No	No Tricoat
stříbrné	9V	1250	745	335	450 - 1.625	450 - 1.250	80	10	206597 <sup>1,2,3</sup>	207621 <sup>1,2,3</sup>
	13V	1250	745	335	450 - 1.625	450 - 1.250	80	10	218202 <sup>1,2,3</sup>	226243 <sup>1,2,3</sup>





<sup>1</sup> U obloukových oken je zářez umístěn na začátku zaoblení. V případě oblouků a segmentových obloukových oken je ukončení nebo rohový převod umístěn na začátku zaoblení, což je důvod, proč se oblast použití FFH obloukových nůžek zvětší o 193 mm (78 mm + 115 mm od ukončení nebo rohového převodu).

<sup>2</sup> Od FFB 1001 mm nebo hmotnosti křídla přes 60kg je předepsáno použití druhých nůžek.

<sup>3</sup> Referenčním bodem polohy šroubů je značka vrubu.

212081







6.1.15 SO Úhelníkové nůžky i.S.							No	No Tricoat		
stříbrné	Nůžky smontované MM		400	0	320 - 400	220 - 320	10	212077	222882	
			600	0	401 - 600	321 - 490	10	212078	222883	
			800	0	601 - 800	491 - 690	10	212079	222884	
				1	630 - 800		10	212080	222885	
				1050	1	801 - 1.050		10	212081 <sup>1</sup>	222886 <sup>1</sup>
				1300	1	1.051 - 1.300		10	212082 <sup>1</sup>	222887 <sup>1</sup>

<sup>1</sup> Od FFB 1301 mm je předepsáno použití druhých nůžek.

## 6.2 Úhelníkové nůžky MULTI MAMMUT



223612

6.2.1 Úhelníkové nůžky MULTI MAMMUT 9V								No	No Tricoat		
stříbrné	pravé	12/18-9	670	0	401 - 670	310 - 400	220	10	<b>223594</b>	<b>223690</b>	
			900	1	671 - 900	601 - 670	220	10	<b>223596</b>	<b>223692</b>	
			1200	1	901 - 1.200		220	10	<b>223598</b>	<b>223694</b>	
			1500	2	1.201 - 1.500		220	10	<b>223600<sup>1</sup></b>	<b>223696<sup>1</sup></b>	
	levé	12/18-9	670	0	401 - 670	310 - 400	220	10	<b>223595</b>	<b>223691</b>	
			900	1	671 - 900	601 - 670	220	10	<b>223597</b>	<b>223693</b>	
			1200	1	901 - 1.200		220	10	<b>223599</b>	<b>223695</b>	
			1500	2	1.201 - 1.500		220	10	<b>223601<sup>1</sup></b>	<b>223697<sup>1</sup></b>	
	pravé	12/20-9	670	0	401 - 670	310 - 400	220	10	<b>223610</b>	<b>223706</b>	
			900	1	671 - 900	601 - 670	220	10	<b>223612</b>	<b>223708</b>	
			1200	1	901 - 1.200		220	10	<b>223614</b>	<b>223710</b>	
			1500	2	1.201 - 1.500		220	10	<b>223616<sup>1</sup></b>	<b>223712<sup>1</sup></b>	
	levé	12/20-9	670	0	401 - 670	310 - 400	220	10	<b>223611</b>	<b>223707</b>	
			900	1	671 - 900	601 - 670	220	10	<b>223613</b>	<b>223709</b>	
			1200	1	901 - 1.200		220	10	<b>223615</b>	<b>223711</b>	
			1500	2	1.201 - 1.500		220	10	<b>223617<sup>1</sup></b>	<b>223713<sup>1</sup></b>	
	bílá RAL 9016	pravé	12/18-9	670	0	401 - 670	310 - 400	220	10	<b>223626</b>	
				900	1	671 - 900	601 - 670	220	10	<b>223628</b>	
				1200	1	901 - 1.200		220	10	<b>223630</b>	
				1500	2	1.201 - 1.500		220	10	<b>223632<sup>1</sup></b>	
levé		12/18-9	670	0	401 - 670	310 - 400	220	10	<b>223627</b>		
			900	1	671 - 900	601 - 670	220	10	<b>223629</b>		
			1200	1	901 - 1.200		220	10	<b>223631</b>		
			1500	2	1.201 - 1.500		220	10	<b>223633<sup>1</sup></b>		
pravé		12/20-9	670	0	401 - 670	310 - 400	220	10	<b>223642</b>		
			900	1	671 - 900	601 - 670	220	10	<b>223644</b>		
			1200	1	901 - 1.200		220	10	<b>223646</b>		
			1500	2	1.201 - 1.500		220	10	<b>223648<sup>1</sup></b>		
levé		12/20-9	670	0	401 - 670	310 - 400	220	10	<b>223643</b>		
			900	1	671 - 900	601 - 670	220	10	<b>223645</b>		
			1200	1	901 - 1.200		220	10	<b>223647</b>		
			1500	2	1.201 - 1.500		220	10	<b>223649<sup>1</sup></b>		

<sup>1</sup> Od FFB 1401 mm je povinné použití druhého páru nůžek. V rozsahu FFB 1401 - 1435 mm je nutné použít nůžky Gr.1200 + druhé nůžky.



223620





6.2.2 Úhelníkové nůžky MULTI MAMMUT 13V								No	No Tricoat	
stříbrné	pravé	12/18-13	670	0	401 - 670	310 - 400	220	10	<b>223602</b>	<b>223698</b>
			900	1	671 - 900	601 - 670	220	10	<b>223604</b>	<b>223700</b>
			1200	1	901 - 1.200		220	10	<b>223606</b>	<b>223702</b>
			1500	2	1.201 - 1.500		220	10	<b>223608<sup>1</sup></b>	<b>223704<sup>1</sup></b>
	levé	12/18-13	670	0	401 - 670	310 - 400	220	10	<b>223603</b>	<b>223699</b>
			900	1	671 - 900	601 - 670	220	10	<b>223605</b>	<b>223701</b>
			1200	1	901 - 1.200		220	10	<b>223607</b>	<b>223703</b>
			1500	2	1.201 - 1.500		220	10	<b>223609<sup>1</sup></b>	<b>223705<sup>1</sup></b>
	pravé	12/20-13	670	0	401 - 670	310 - 400	220	10	<b>223618</b>	<b>223714</b>
			900	1	671 - 900	601 - 670	220	10	<b>223620</b>	<b>223716</b>
			1200	1	901 - 1.200		220	10	<b>223622</b>	<b>223718</b>
			1500	2	1.201 - 1.500		220	10	<b>223624<sup>1</sup></b>	<b>223720<sup>1</sup></b>
	levé	12/20-13	670	0	401 - 670	310 - 400	220	10	<b>223619</b>	<b>223715</b>
			900	1	671 - 900	601 - 670	220	10	<b>223621</b>	<b>223717</b>
			1200	1	901 - 1.200		220	10	<b>223623</b>	<b>223719</b>
			1500	2	1.201 - 1.500		220	10	<b>223625<sup>1</sup></b>	<b>223721<sup>1</sup></b>
bílá RAL 9016	pravé	12/18-13	670	0	401 - 670	310 - 400	220	10	<b>223634</b>	
			900	1	671 - 900	601 - 670	220	10	<b>223636</b>	
			1200	1	901 - 1.200		220	10	<b>223638</b>	
			1500	2	1.201 - 1.500		220	10	<b>223640<sup>1</sup></b>	
	levé	12/18-13	670	0	401 - 670	310 - 400	220	10	<b>223635</b>	
			900	1	671 - 900	601 - 670	220	10	<b>223637</b>	
			1200	1	901 - 1.200		220	10	<b>223639</b>	
			1500	2	1.201 - 1.500		220	10	<b>223641<sup>1</sup></b>	
	pravé	12/20-13	670	0	401 - 670	310 - 400	220	10	<b>223650</b>	
			900	1	671 - 900	601 - 670	220	10	<b>223652</b>	
			1200	1	901 - 1.200		220	10	<b>223654</b>	
			1500	2	1.201 - 1.500		220	10	<b>223656<sup>1</sup></b>	
	levé	12/20-13	670	0	401 - 670	310 - 400	220	10	<b>223651</b>	
			900	1	671 - 900	601 - 670	220	10	<b>223653</b>	
			1200	1	901 - 1.200		220	10	<b>223655</b>	
			1500	2	1.201 - 1.500		220	10	<b>223657<sup>1</sup></b>	

<sup>1</sup> Od FFB 1401 mm je povinné použití druhého páru nůžek. V rozsahu FFB 1401 - 1435 mm je nutné použít nůžky Gr.1200 + druhé nůžky.

## 6.4 Nůžky INVISIBLE



206816 

206817 

6.4.1 Štulpy nůžek VV INVISIBLE								N <sup>o</sup>	N <sup>o</sup> Tricoat
stříbrné	690	0	490 - 690	385 - 600	20	<b>206810</b>			
	800	0	691 - 800	601 - 700	20	<b>206816</b>			
	1050	1	801 - 1.050		20	<b>206817</b>			
	1300	1	1.051 - 1.300		20	<b>217861</b>			

212670





H 6.4.2 Nůžky s ložiskem VV INVISIBLE							N <sup>o</sup>	N <sup>o</sup> Tricoat	
stříbrné	Šroubovací osa 12 mm	pravé	9V FT18	690	385 - 690	80	10	<b>212670<sup>1</sup></b>	
				800/1050/1300	691 - 1.300	80	10	<b>212666</b>	
		levé	9V FT18	690	385 - 690	80	10	<b>212671<sup>1</sup></b>	
				800/1050/1300	691 - 1.300	80	10	<b>212667</b>	
	Šroubovací osa 13 mm	pravé	9V	690	385 - 690	100	10	<b>206336<sup>1</sup></b>	
				800/1050/1300	691 - 1.300	100	10	<b>206349</b>	
		levé	9V	690	385 - 690	100	10	<b>206337<sup>1</sup></b>	
				800/1050/1300	691 - 1.300	100	10	<b>206350</b>	

<sup>1</sup> V kombinaci s otevíravým a sklopným štulpem obj. č.208993.

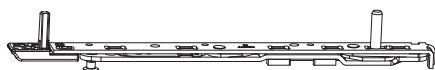
207689







H 6.4.3 SO nůžky s ložiskem VV INVISIBLE							N <sup>o</sup>	N <sup>o</sup> Tricoat	
stříbrné	Šroubovací osa 12 mm	pravé	9V FT18	690	385 - 690	80	10	<b>212674</b>	
				800/1050/1300	691 - 1.300	80	10	<b>212678</b>	
		levé	9V FT18	690	385 - 690	80	10	<b>212675</b>	
				800/1050/1300	691 - 1.300	80	10	<b>212679</b>	
	Šroubovací osa 13 mm	pravé	9V	690	385 - 690	100	10	<b>207689</b>	
				800/1050/1300	691 - 1.300	100	10	<b>207699</b>	
		levé	9V	690	385 - 690	100	10	<b>207690</b>	
				800/1050/1300	691 - 1.300	100	10	<b>207700</b>	



## 6.5 Nůžky MULTI POWER



217348 

6.5.1 OS/SO štulpy nůžek MULTI POWER									No	No Tricoat
stříbrné	600	0	465 - 600	370 - 490	150	20	<b>217346</b>	<b>225296*</b>		
		800	601 - 800	491 - 690	150	20	<b>217347</b>	<b>225297*</b>		
	1050	1	801 - 1.050		150	20	<b>217348</b>	<b>225298*</b>		
		1300	1	1.051 - 1.300		150	20	<b>217349<sup>1</sup></b>	<b>225299<sup>1</sup>*</b>	

<sup>1</sup> Od FFB 1301 mm je předepsáno použití druhých nůžek.

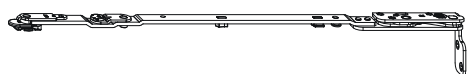

217474



6.5.2 OS raménka nůžek s ložiskem DŘEVO MULTI POWER				L				No	No Tricoat	
stříbrné	pravé	9V	Dřevo FT24	600/800	330	370 - 800	150	10	<b>217468</b>	<b>225305*</b>
				1050/1300	442	801 - 1.300	150	10	<b>217472</b>	<b>225309*</b>
		13V	Dřevo FT24	600/800	330	370 - 800	150	10	<b>217470</b>	<b>225307*</b>
				1050/1300	442	801 - 1.300	150	10	<b>217474</b>	<b>225311*</b>
	levé	9V	Dřevo FT24	600/800	330	370 - 800	150	10	<b>217469</b>	<b>225306*</b>
				1050/1300	442	801 - 1.300	150	10	<b>217473</b>	<b>225310*</b>
		13V	Dřevo FT24	600/800	330	370 - 800	150	10	<b>217471</b>	<b>225308*</b>
				1050/1300	442	801 - 1.300	150	10	<b>217475</b>	<b>225312*</b>



217482



6.5.3 OS raménka nůžek s ložiskem PVC MULTI POWER				L				No	No Tricoat	
stříbrné	pravé	9V	PVC FT30	600/800	330	370 - 800	150	10	<b>217476</b>	
				1050/1300	442	801 - 1.300	150	10	<b>217480</b>	
		13V	PVC FT30	600/800	330	370 - 800	150	10	<b>217478</b>	<b>225315</b>
				1050/1300	442	801 - 1.300	150	10	<b>217482</b>	<b>225319</b>
	levé	9V	PVC FT30	600/800	330	370 - 800	150	10	<b>217477</b>	
				1050/1300	442	801 - 1.300	150	10	<b>217481</b>	
		13V	PVC FT30	600/800	330	370 - 800	150	10	<b>217479</b>	<b>225316</b>
				1050/1300	442	801 - 1.300	150	10	<b>217483</b>	<b>225320</b>

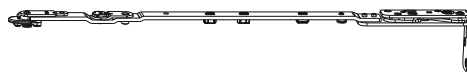

217490



6.5.4 SO raménka nůžek s ložiskem DŘEVO MULTI POWER				L				No	No Tricoat	
stříbrné	pravé	9V	Dřevo FT24	600/800	330	370 - 800	150	10	<b>217484</b>	<b>225531</b>
				1050/1300	442	801 - 1.300	150	10	<b>217488</b>	<b>225533</b>
		13V	Dřevo FT24	600/800	330	370 - 800	150	10	<b>217486</b>	<b>225535</b>
				1050/1300	442	801 - 1.300	150	10	<b>217490</b>	<b>225537</b>
	levé	9V	Dřevo FT24	600/800	330	370 - 800	150	10	<b>217485</b>	<b>225532</b>
				1050/1300	442	801 - 1.300	150	10	<b>217489</b>	<b>225534</b>
		13V	Dřevo FT24	600/800	330	370 - 800	150	10	<b>217487</b>	<b>225536</b>
				1050/1300	442	801 - 1.300	150	10	<b>217491</b>	<b>225538</b>



217498





6.5.5 SO raménka nůžek s ložiskem PVC MULTI POWER				L				No	No Tricoat	
stříbrné	pravé	9V	PVC FT30	1050/1300	442	801 - 1.300	150	10	217496	
		13V	PVC FT30	600/800	330	370 - 800	150	10	217494	225543
				1050/1300	442	801 - 1.300	150	10	217498	225545
	levé	9V	PVC FT30	600/800	330	370 - 800	150	10	217493	
				1050/1300	442	801 - 1.300	150	10	217497	
		13V	PVC FT30	600/800	330	370 - 800	150	10	217495	225544
			1050/1300	442	801 - 1.300	150	10	217499	225546	

217564



217566





6.5.6 Štulpy nůžek pro spárové větrání MULTI POWER									No	No Tricoat
stříbrné	pravé	600	0	465 - 600	370 - 490	150	20	217562 <sup>1</sup>	225523 <sup>1*</sup>	
		800	0	601 - 800	491 - 690	150	20	217564 <sup>1</sup>	225525 <sup>1*</sup>	
		1050	1	801 - 1.050		150	20	217566 <sup>1</sup>	225527 <sup>1*</sup>	
		1300	1	1.051 - 1.300		150	20	217568 <sup>1,2</sup>	225529 <sup>1,2*</sup>	
	levé	600	0	465 - 600	370 - 490	150	20	217563 <sup>1</sup>	225524 <sup>1*</sup>	
		800	0	601 - 800	491 - 690	150	20	217565 <sup>1</sup>	225526 <sup>1*</sup>	
		1050	1	801 - 1.050		150	20	217567 <sup>1</sup>	225528 <sup>1*</sup>	
		1300	1	1.051 - 1.300		150	20	217569 <sup>1,2</sup>	225530 <sup>1,2*</sup>	

<sup>1</sup> Používejte pouze ve spojení s "horizontálním sklopním dílem" (s "vertikálním sklopným dílem" lze křídlo vykopit ven z uzávěru).

<sup>2</sup> Od FFB 1301 mm je předepsáno použití druhých nůžek.



217647

6.5.7 Raménka nůžek s ložiskem pro spárové větrání DŘEVO MULTI POWER				L				No	No Tricoat	
stříbrné	pravé	9V	Dřevo FT24	600/800	330	370 - 800	150	10	217641 <sup>1</sup>	225547 <sup>1</sup>
				1050/1300	442	801 - 1.300	150	10	217645 <sup>1</sup>	225549 <sup>1</sup>
		13V	Dřevo FT24	600/800	330	370 - 800	150	10	217643 <sup>1</sup>	225551 <sup>1*</sup>
				1050/1300	442	801 - 1.300	150	10	217647 <sup>1</sup>	225553 <sup>1*</sup>
	levé	9V	Dřevo FT24	600/800	330	370 - 800	150	10	217642 <sup>1</sup>	225548 <sup>1</sup>
				1050/1300	442	801 - 1.300	150	10	217646 <sup>1</sup>	225550 <sup>1</sup>
		13V	Dřevo FT24	600/800	330	370 - 800	150	10	217644 <sup>1</sup>	225552 <sup>1*</sup>
				1050/1300	442	801 - 1.300	150	10	217648 <sup>1</sup>	225554 <sup>1*</sup>

<sup>1</sup> Používejte pouze ve spojení s "horizontálním sklopním dílem" (s "vertikálním sklopným dílem" lze křídlo vykopit ven z uzávěru).



217655





K	6.5.8 Raménka nůžek s ložiskem pro spárové větrání PVC MULTI POWER				L				No	No Tricoat
	stříbrné	pravé	9V	PVC FT30						
				600/800	330	370 - 800	150	10	217649 <sup>1</sup>	
				1050/1300	442	801 - 1.300	150	10	217653 <sup>1</sup>	
				600/800	330	370 - 800	150	10	217651 <sup>1</sup>	225559 <sup>1*</sup>
				1050/1300	442	801 - 1.300	150	10	217655 <sup>1</sup>	225561 <sup>1*</sup>
		levé		600/800	330	370 - 800	150	10	217650 <sup>1</sup>	
				1050/1300	442	801 - 1.300	150	10	217654 <sup>1</sup>	
				600/800	330	370 - 800	150	10	217652 <sup>1</sup>	225560 <sup>1*</sup>
				1050/1300	442	801 - 1.300	150	10	217656 <sup>1</sup>	225562 <sup>1*</sup>

<sup>1</sup> Používejte pouze ve spojení s "horizontálním sklopním dílem" (s "vertikálním sklopným dílem" lze křídlo vyklopit ven z uzávěru).

## 6.6 Nůžky Komfort



215055



6.6.1 Štulpy nůžek Komfort							N <sup>o</sup>	N <sup>o</sup> Tricoat
stříbrné	pravé	800	0	601 - 800	490 - 600	10	<b>215053</b>	<b>218588</b>
		1050	1	801 - 1.050		10	<b>215055</b>	<b>218590</b>
	levé	800	0	601 - 800	490 - 600	10	<b>215054</b>	<b>218589</b>
		1050	1	801 - 1.050		10	<b>215056</b>	<b>218591</b>

215051





6.6.2 Raménka nůžek Komfort						N <sup>o</sup>	N <sup>o</sup> Tricoat
stříbrné	pravé	800/1050	490 - 1.050	80	10	<b>215051</b>	<b>218049</b>
	levé	800/1050	490 - 1.050	80	10	<b>215052</b>	<b>218050</b>

209723



101548





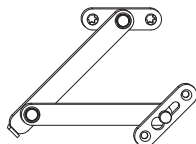

6.7 Sklopné nůžky			L			N <sup>o</sup>	N <sup>o</sup> Tricoat
stříbrné	sklopné nůžky s přichycením vrutem		204	80	20	<b>209723<sup>1</sup></b>	<b>216249<sup>1</sup></b>
	sklopné nůžky s připevňovací destičkou		204	80	20	<b>101548<sup>1</sup></b>	<b>209297<sup>1*</sup></b>

<sup>1</sup> Poznámka: Minimální FFH závisí na profilu okna nebo geometrii okna!

11026



6.8 Nůžky pro nadsvětlíky			L					N <sup>o</sup>	N <sup>o</sup> Tricoat
stříbrné	190	1.400	210 - 800	40	20	<b>11026<sup>1</sup></b>	<b>101354<sup>1</sup></b>		
	250	1.400	210 - 800	40	20	<b>11027<sup>1</sup></b>			



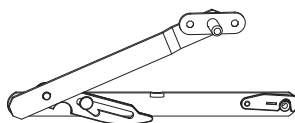
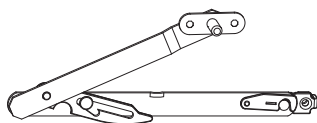

<sup>1</sup> Vždy používejte dva kusy na jedno okno!

## 6.9 Záchytné nůžky



455347

104304

6.9.1 Záchytné nůžky							
stříbrné	záchytné a čistící nůžky s připevňovací destičkou	Gr. 1	300 - 500	40	10	<b>455347</b> <sup>1,2</sup>	<b>210263</b> <sup>1,2</sup>
		Gr. 2	501 - 1.200	40	10	<b>455348</b> <sup>1,3</sup>	<b>211390</b> <sup>1,3</sup>
	záchytné a čistící nůžky pro připevnění šroubem	Gr. 1	300 - 500	40	10	<b>104304</b> <sup>1,2</sup>	
		Gr. 2	501 - 1.200	40	10	<b>104305</b> <sup>1,3</sup>	





<sup>1</sup> 1 Kus = 1 Pár.

<sup>2</sup> Oblast použití u VV: 520 - 620 mm.

<sup>3</sup> Oblast použití u VV: 621 - 1200 mm.

## 6.9.2 Příslušenství pro záchytné nůžky

455386 

K 6.9.2.1 Podkladové desky pro zachytné a čistící nůžky					
stříbrné		1	20	<b>455386</b>	<b>363378</b>
		3	20	<b>455349</b>	
		6	20	<b>455387</b>	
	5° šikmé	20	<b>455388</b>		

368425 

6.9.2.2 uchycovací čepy s otvorem pro šroub pro záchytné a čistící nůžky					
stříbrné		40	100	<b>368425</b>	

## 6.10 Příslušenství nůžek

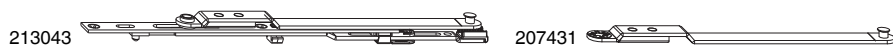

6.10.1 Druhé nůžky		L		N <sup>o</sup>	N <sup>o</sup> Tricoat
stříbrné	druhé nůžky MM smontované bez spárového větrání	235	20	<b>213043</b>	<b>216209*</b>
	raménka druhých nůžek MM bez spárového větrání	231,5	20	<b>207431</b>	<b>209858</b>
	štulpy druhých nůžek MM	235	20	<b>203765</b>	<b>207626*</b>

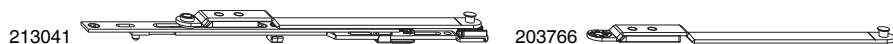

6.10.2 Druhé nůžky pro spárové větrání		L		N <sup>o</sup>	N <sup>o</sup> Tricoat
stříbrné	pravé druhé nůžky MM smontované	235	20	<b>213041</b>	<b>223020</b>
	levé druhé nůžky MM smontované	235	20	<b>213042</b>	<b>223021</b>
	pravé raménka druhých nůžek MM	231,5	20	<b>203766</b>	<b>207627*</b>
	levé raménka druhých nůžek MM	231,5	20	<b>203767</b>	<b>207628*</b>
	štulpy druhých nůžek MM	235	20	<b>203765</b>	<b>207626*</b>



6.10.3 Druhé nůžky pro SO		L		N <sup>o</sup>	N <sup>o</sup> Tricoat
stříbrné	druhé nůžky MM smontované pro SO	330	20	<b>213044</b>	<b>223023</b>
	raménka druhých nůžek MM pro SO	231,5	20	<b>205933</b>	<b>219511</b>
	štulpy druhých nůžek MM pro SO	330	20	<b>205934</b>	



6.10.4 Druhé nůžky pro oblouková okna		L		N <sup>o</sup>	N <sup>o</sup> Tricoat
stříbrné	s 2 i.S.	945	10	<b>203961</b>	<b>207629</b>

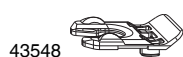

6.10.5 Protiprůvanové pojistky			N <sup>o</sup>	N <sup>o</sup> Tricoat
bílá RAL 9016	pro nůžky Gr.2-4 nebo Gr.1050/1300	100	<b>43549</b>	
černá	pro nůžky Gr.00-1 nebo Gr.400/600/800	100	<b>43548</b>	

43551 

<b>6.10.6 Omezovače nůžek</b>			<b>N<sup>o</sup></b>	<b>N<sup>o</sup></b> Tricoat
bílá RAL 9016	pro nůžky Gr.2-4 nebo Gr.1050/1300	100	<b>43552<sup>1,2</sup></b>	
	pro druhé nůžky	100	<b>43613<sup>1</sup></b>	
černá	pro nůžky Gr.00-1 nebo Gr.600/800	100	<b>43551<sup>1,3</sup></b>	

<sup>1</sup> Omezení nůžek je žádoucí při FFH pod 600mm. Při FFH přes 600mm může být nutné použít omezení nůžek z důvodu tvaru profilu.

<sup>2</sup> Otevření: 80 mm u nůžek Gr. 1050; 60 mm u Gr. 1300.

<sup>3</sup> Otevření: 75 mm u nůžek Gr. 600; 60 mm u Gr. 800.

369474  366012 

<b>6.10.7 Protiprůvanové pojistky / Omezovače nůžek MULTI POWER</b>			<b>N<sup>o</sup></b>	<b>N<sup>o</sup></b> Tricoat
šedá F1	Protiprůvanové pojistky Multi Power	20	<b>369474</b>	
modrá	Omezovače nůžek pro nůžky Multi Power Gr.0/1 nebo Gr.600/800	100	<b>366011<sup>1,2</sup></b>	
hnědá	Omezovače nůžek pro nůžky Multi Power Gr.2/3 nebo Gr.1050/1300	100	<b>366012<sup>2,3</sup></b>	

<sup>1</sup> Šířka sklápění 100 mm.

<sup>2</sup> Omezení nůžek pro FFH pod 600 mm je povinné. Pro FFH nad 600 mm může být nutný omezovač nůžek, pokud to vyžaduje profil okna nebo geometrie okna.

<sup>3</sup> Šířka sklápění 110 mm.

368077  371916 

<b>6.10.8 Protiprůvanové pojistky / Omezovače nůžek MULTI MAMMUT</b>			<b>N<sup>o</sup></b>	<b>N<sup>o</sup></b> Tricoat
stříbrné	Protiprůvanové pojistky s těžkým rastrováním Multi Mammut	50	<b>368075</b>	
	Protiprůvanové pojistky s lehkým rastrováním Multi Mammut	50	<b>368076<sup>1</sup></b>	
	Omezovače nůžek pro nůžky Multi Mammut	50	<b>368077<sup>2</sup></b>	
modrá	Protiprůvanové pojistky pro nůžky Multi Mammut	50	<b>371916</b>	

<sup>1</sup> Pro hmotnosti křídla do 60 kg.

<sup>2</sup> Omezení nůžek pro FFH pod 600 mm je povinné. Pro FFH nad 600 mm může být nutný omezovač nůžek, pokud to vyžaduje profil okna nebo geometrie okna.

MACO  
MULTI-MATIC



Nůžky





## 7 Otvíravé závěsy a přítlačné panty

---

- 7.1 Otvíravé závěsy AS/DTuni/PVC \_\_\_\_\_
- 7.2 Sklopné a otvíravé závěsy AS/DTuni/PVC \_\_\_\_\_
- 7.3 Štulpy otvír. sklopného závěsu PVC \_\_\_\_\_
- 7.4 Otvíravé závěsy MULTI MAMMUT \_\_\_\_\_
- 7.5 Otvíravé závěsy TV \_\_\_\_\_
- 7.6 Sklopné a otvíravé závěsy INVISIBLE \_\_\_\_\_
- 7.7 Sklopné a otvíravé závěsy MULTI POWER \_\_\_\_\_
- 7.8 Otvíravá ložiska 3kř. \_\_\_\_\_
- 7.9 Závěsy Paumelle \_\_\_\_\_
- 7.10 Přítlačné panty \_\_\_\_\_
- 7.11 Krytky pro přítlačné panty \_\_\_\_\_

## 7 Otvírací závěsy a přítlačné panty

### 7.1 Otvírací závěsy AS/DTuni/PVC

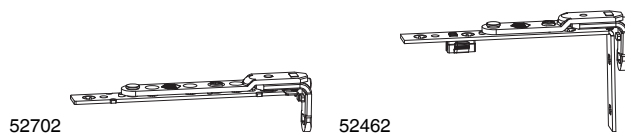

7.1.1 Otvírací závěsy AS/DTuni/PVC			L	kg	cube	No	No Tricoat
stříbrné	otvírací závěsy horní DTuni	Dřevo	152	130	50	52702 <sup>1,2,3</sup>	202314 <sup>1,2,3*</sup>
	otvírací závěsy horní AS/PVC úhelníkové provedení		143	120	50	52462 <sup>4</sup>	201764 <sup>4*</sup>

<sup>1</sup> Použit při potřebě prodlužovacího štlupu 360327.

<sup>2</sup> Pro 13V bez kovací drážky použít distanční klips 357881.

<sup>3</sup> Pro kovací drážku použít podložku 41103.

<sup>4</sup> Použit při potřebě prodlužovacího štlupu 215572.



202271

7.1.2 Raménka otv�rací sklopného závěsu			kg	cube	No	No Tricoat
stříbrné	otv�rací ložiska AS/DT/PVC pro štlup otv. závěsu MM		120	50	202271 <sup>1</sup>	208314 <sup>1*</sup>

<sup>1</sup> S úhelníkem DT 130kg.

206315

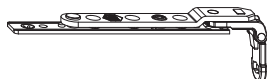

### 7.1.5 Otvírací závěsy pro šikmá okna



**N<sub>0</sub>**

**N<sub>0</sub>**  
Tricoat

stříbrné					20	206315 <sup>1,2,3</sup>	207669 <sup>1,2,3</sup>
----------	--	--	--	--	----	-------------------------	-------------------------

<sup>1</sup> Použit při potřebě prodlužovacího štulpu 360327.

<sup>2</sup> Pro 13V bez kovací drážky použít distanční klips 357881.

<sup>3</sup> Pro kovací drážku použít podložku 41103.

202269



### 7.1.6 Štulpy otvíracího závěsu zakratitelné



**L**



**N<sub>0</sub>**

**N<sub>0</sub>**  
Tricoat

stříbrné	600	0	498,5	350 - 600	20	202269	207671*
	800	0	697,5	601 - 800	20	205940	207672*
s 1 i.S.	1050	1	947,5	801 - 1.050	20	205941	207673*

41103



### **H** 7.1.7 Podložky pro kovací drážku pro otvírací závěs horní DT/TO

**L**



**N<sub>0</sub>**

**N<sub>0</sub>**  
Tricoat

Přírodní					142	100	41103
----------	--	--	--	--	-----	-----	-------

360327



### 7.1.8 Prodlužovací štulpy pro otvírací závěs

**L**





**N<sub>0</sub>**

**N<sub>0</sub>**  
Tricoat

stříbrné							
			DTuni	180	20	360327	
			AS/PVC	180	20	215572	

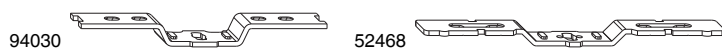
## 7.2 Sklopné a otvírací závěsy AS/DTuni/PVC





7.2.1 Sklopné a otvírací závěsy AS/DT/PVC		L			N <sup>o</sup>	N <sup>o</sup> Tricoat
stříbrné	sklopné a otvírací závěsy AS/PVC	130	80	100	94030 <sup>1,2</sup>	355816 <sup>1,2*</sup>
	sklopné a otvírací závěsy AS/DTuni	159	80	100	52468 <sup>1,3</sup>	205066 <sup>1,3*</sup>

<sup>1</sup> Při použití záchytných a čistících nůžek je maximální hmotnost křídla 40 kg. Dodržovat směrnici FPKF der Gütegemeinschaft Schlösser und Beschläge!

<sup>2</sup> Pro kovací drážku.

<sup>3</sup> Bez kovací drážky.



7.2.2 Sklopné a otvírací závěsy seřiditelné		L			N <sup>o</sup>	N <sup>o</sup> Tricoat
stříbrné	sklopné závěsy samoregulovatelné	106	30	50	58472 <sup>1,2</sup>	
	sklopné a otvírací závěsy AS/DT/PVC seřiditelné	146	80	50	52321 <sup>1,2</sup>	201631 <sup>1,2*</sup>
	sklopné a otvírací závěsy DTuni seřiditelné	200	80	50	206340 <sup>1</sup>	213789 <sup>1</sup>

<sup>1</sup> Při použití záchytných a čistících nůžek je maximální hmotnost křídla 40 kg. Dodržovat směrnici FPKF der Gütegemeinschaft Schlösser und Beschläge!

<sup>2</sup> Pro kovací drážku.

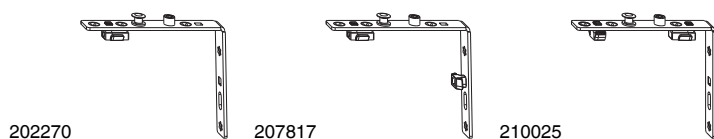



7.3 Štulpy otvír. sklopného závěsu PVC			N <sup>o</sup>	N <sup>o</sup> Tricoat
stříbrné	štulpy otvír. sklopného závěsu MM	50	202270	207670*
	štulpy otvír. sklopného závěsu s druhým fix.dílem MM	50	207817	211318
	štulpy otvír. sklopného závěsu pro automaty MM	50	210025	

## 7.4 Otvírací závěsy MULTI MAMMUT



223776

7.4.1 Otvírací závěsy zakratitelné MULTI MAMMUT					<b>No</b>	<b>No</b> Tricoat
stříbrné	pravé	12/18-9	400 - 635	10	<b>223776</b> <sup>1</sup>	<b>223800</b> <sup>1</sup>
	levé	12/18-9	400 - 635	10	<b>223777</b> <sup>1</sup>	<b>223801</b> <sup>1</sup>
	pravé	12/18-13	400 - 635	10	<b>223778</b> <sup>1</sup>	<b>223802</b> <sup>1</sup>
	levé	12/18-13	400 - 635	10	<b>223779</b> <sup>1</sup>	<b>223803</b> <sup>1</sup>
	pravé	12/20-9	400 - 635	10	<b>223780</b> <sup>1</sup>	<b>223804</b> <sup>1</sup>
	levé	12/20-9	400 - 635	10	<b>223781</b> <sup>1</sup>	<b>223805</b> <sup>1</sup>
	pravé	12/20-13	400 - 635	10	<b>223782</b> <sup>1</sup>	<b>223806</b> <sup>1</sup>
	levé	12/20-13	400 - 635	10	<b>223783</b> <sup>1</sup>	<b>223807</b> <sup>1</sup>
Bílé RAL 9016	pravé	12/18-9	400 - 635	10	<b>223784</b> <sup>1</sup>	
	levé	12/18-9	400 - 635	10	<b>223785</b> <sup>1</sup>	
	pravé	12/18-13	400 - 635	10	<b>223786</b> <sup>1</sup>	
	levé	12/18-13	400 - 635	10	<b>223787</b> <sup>1</sup>	
	pravé	12/20-9	400 - 635	10	<b>223788</b> <sup>1</sup>	
	levé	12/20-9	400 - 635	10	<b>223789</b> <sup>1</sup>	
	pravé	12/20-13	400 - 635	10	<b>223790</b> <sup>1</sup>	
	levé	12/20-13	400 - 635	10	<b>223791</b> <sup>1</sup>	

<sup>1</sup> Oblast použití "Otvíracího závěsu fix" je jako u "Otvíracího závěsu zakratitelného" 400 - 635, proto použít prodloužení štlupu popř. střední závoru

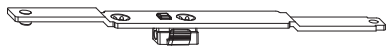

202867

7.4.2 Prodloužení štlupu pro otvírací závěs MULTI MAMMUT					<b>No</b>	<b>No</b> Tricoat
stříbrné			385 - 1.800	20	<b>202867</b> <sup>1</sup>	<b>216725</b> <sup>1</sup>

<sup>1</sup> V kombinaci s otvíracím závěsem zakratitelným lze použít i jako "otvírací závěs fix".

## 7.6 Otvírací sklopné, otvírací a sklopné závěsy VV Invisible

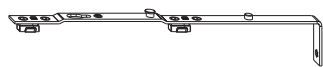

208993

### 7.6.1 Štulpý otvíracího a sklopného závěsu VV INVISIBLE

L

kg



No

No  
Tricoat

stříbrné

290

100

20

**208993<sup>1</sup>**

<sup>1</sup> Pro kombinaci s nejmenšími nůžkami s ložiskem VV Invisible (385-690).

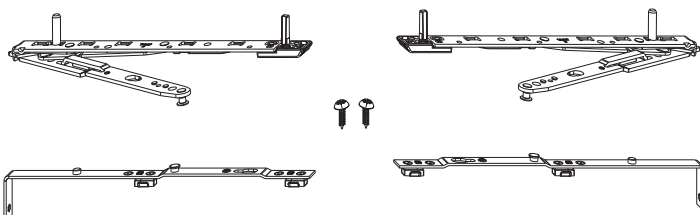

101901

### H 7.6.2 Kartony sklopné VV INVISIBLE



No

No  
Tricoat

stříbrné

šroubovací osa 12 mm

sklopné FT18 9V

520 - 1.200

300 - 2.400

10

**103302**

šroubovací osa 13 mm

sklopné 9V

520 - 1.200

300 - 2.400

10

**101901<sup>1</sup>**

<sup>1</sup> Od FFH 520 mm: použít záchytné a čistící nůžky.

## 7.7 Sklopné a otvírací závěsy Multi Power

### 7.7.1 Štulpy a raménka s ložiskem Multi Power



217729

7.7.1.1 Otvírací a sklopné štulpy fix Multi Power							No	No Tricoat
stříbrné				255 - 1.400	150	20	217729	225300*



217687

7.7.1.2 Štulpy otvíracího závěsu zakratitelné Multi Power								No	No Tricoat
stříbrné	600	0	401 - 600	320 - 490	20		217685	225301*	
	800	0	601 - 800		20		217686	225302*	
	1050	1	801 - 1.050		20		217687	225303*	
	1300	1	1.051 - 1.300		20		217688	225304*	

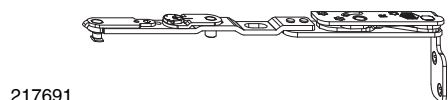

217691

H 7.7.1.3 Raménka otvíracího závěsu s ložiskem DŘEVO Multi Power							No	No Tricoat
stříbrné	Dřevo FT24	pravé	9V	255 - 1.400	150	10	217689	225321*
		levé	9V	255 - 1.400	150	10	217690	225322*
		pravé	13V	255 - 1.400	150	10	217691	225323*
		levé	13V	255 - 1.400	150	10	217692	225324*

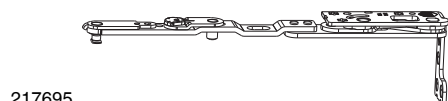

217695

K 7.7.1.4 Raménka otvíracího závěsu s ložiskem PVC Multi Power							No	No Tricoat
stříbrné	PVC FT30	pravé	9V	255 - 1.400	150	10	217693	
		levé	9V	255 - 1.400	150	10	217694	
		pravé	13V	255 - 1.400	150	10	217695	225328*
		levé	13V	255 - 1.400	150	10	217696	225329*

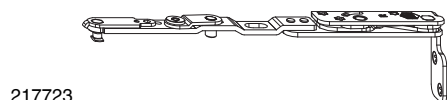

217723



H 7.7.1.5 Raménka sklopného závěsu s ložiskem DŘEVO Multi Power							No	No Tricoat
stříbrné	Dřevo FT24	pravé	9V	255 - 1.200	80	10	217721 <sup>1,2</sup>	225338 <sup>1,2</sup>
		levé	9V	255 - 1.200	80	10	217722 <sup>1,2</sup>	225339 <sup>1,2</sup>
		pravé	13V	255 - 1.200	80	10	217723 <sup>1,2</sup>	225340 <sup>1,2</sup>
		levé	13V	255 - 1.200	80	10	217724 <sup>1,2</sup>	225341 <sup>1,2</sup>

<sup>1</sup> Dodržujte pokyny FPKF (záchytné a čistící nůžky) Gütegemeinschaft Schlösser und Beschläge e.V. ([www.schlossindustrie.de](http://www.schlossindustrie.de))!

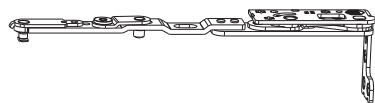
<sup>2</sup> FFB max. 2400 mm. Křídlo musí být stabilizováno, např. přilepeno.



217727

<b>K 7.7.1.6 Raménka sklopného závěsu s ložiskem PVC Multi Power</b>							<b>No</b>	<b>No</b> Tricoat
stříbrné	PVC FT30	pravé	9V	255 - 1.200	80	10	<b>217725<sup>1,2</sup></b>	
		levé	9V	255 - 1.200	80	10	<b>217726<sup>1,2</sup></b>	
		pravé	13V	255 - 1.200	80	10	<b>217727<sup>1,2</sup></b>	<b>225344<sup>1,2</sup></b>
		levé	13V	255 - 1.200	80	10	<b>217728<sup>1,2</sup></b>	<b>225345<sup>1,2</sup></b>



<sup>1</sup> Dodržujte pokyny FPKF (záchytné a čisticí nůžky) Gütegemeinschaft Schlösser und Beschläge e.V. ([www.schlossindustrie.de](http://www.schlossindustrie.de))!

<sup>2</sup> FFB max. 2400 mm. Křídlo musí být stabilizováno, např. přilepeno.

## 7.7.2 Raménka otvíracího závěsu s ložiskem 3kř. Multi Power





217715

<b>H 7.7.2.1 Raménka otvíracího závěsu s ložiskem 3-kř. DŘEVO Multi Power</b>							<b>No</b>	<b>No</b> Tricoat
stříbrné	Dřevo FT24	pravé	9V	255 - 1.400	80	10	<b>217713</b>	<b>225330</b>
		levé	9V	255 - 1.400	80	10	<b>217714</b>	<b>225331</b>
		pravé	13V	255 - 1.400	80	10	<b>217715</b>	<b>225332</b>
		levé	13V	255 - 1.400	80	10	<b>217716</b>	<b>225333</b>



217719

<b>K 7.7.2.2 Raménka otvíracího závěsu s ložiskem 3-kř. PVC Multi Power</b>							<b>No</b>	<b>No</b> Tricoat
stříbrné	PVC FT30	pravé	9V	255 - 1.400	80	10	<b>217717</b>	
		levé	9V	255 - 1.400	80	10	<b>217718</b>	
		pravé	13V	255 - 1.400	80	10	<b>217719</b>	<b>225336</b>
		levé	13V	255 - 1.400	80	10	<b>217720</b>	<b>225337</b>



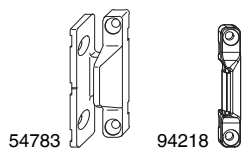

## 7.10 Přítlačné panty

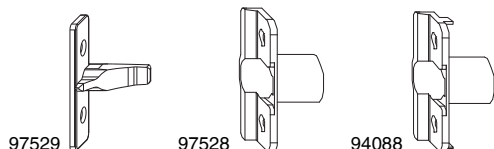

7.10.1 Přítlačné panty našroubované (AS)				<b>No</b>	<b>No</b> Tricoat
stříbrné	křídlové a rámové díly	Dřevo	100	<b>52389<sup>1</sup></b>	<b>205054<sup>1</sup></b>
		PVC	100	<b>54783<sup>1</sup></b>	
	křídlové a rámové díly pro nalehávkové těsnění	Dřevo	100	<b>55028<sup>1</sup></b>	<b>205055<sup>1</sup></b>
		Dřevo/PVC/Alu-Dřevo	10 )	<b>94218<sup>1</sup></b>	
bílé RAL 9016	křídlové a rámové díly	Dřevo/PVC/Alu-Dřevo	10 )	<b>94217<sup>1</sup></b>	
		Dřevo	100	<b>206585<sup>1</sup></b>	
	křídlové a rámové díly pro nalehávkové těsnění	Dřevo	100	<b>21062<sup>1</sup></b>	

<sup>1</sup> Nevhodný pro VV!



H 7.10.2 Přítlačné panty k zavrtání pro DŘEVO				<b>No</b>	<b>No</b> Tricoat
stříbrné	křídlové díly 9V/13V	pro kovací drážku	100	<b>94089<sup>1,2</sup></b>	<b>359574<sup>1,2*</sup></b>
	křídlové díly 9V	bez kovací drážky		<b>97529<sup>2</sup></b>	<b>359211<sup>2</sup></b>
	křídlové díly 13V	bez kovací drážky		<b>360009<sup>2</sup></b>	<b>360264<sup>2*</sup></b>
	rámové díly	4L 9V	100	<b>360006<sup>2</sup></b>	<b>368198<sup>2</sup></b>
		4L 13V	100	<b>358996<sup>2</sup></b>	<b>363377<sup>2</sup></b>
		Eurofalz FT18 9V	100	<b>354090<sup>2</sup></b>	<b>363297<sup>2</sup></b>
		Eurofalz FT20 9V	100	<b>97528<sup>2</sup></b>	<b>359594<sup>2</sup></b>
		Eurofalz FT24 13V	100	<b>357741<sup>2</sup></b>	<b>359573<sup>2*</sup></b>
		Eurofalz FT30 13V	100	<b>368015<sup>2</sup></b>	
		Euronut FT20 9V	100	<b>94088<sup>2</sup></b>	
Euronut FT25 9V		100	<b>94258<sup>2</sup></b>		

<sup>1</sup> Pro kovací drážku použít podložku 40485.

<sup>2</sup> Vhodné pro Multi Power, Invisible, TV, 180kg, TO, DT, AS

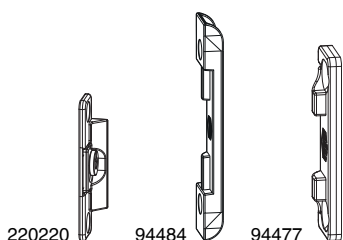

**H 7.10.3 Přítlačné panty skryté hloubkově seřiditelné pro DŘEVO**



**No**

**No**  
Tricoat

Silber	křídlové díly hloubkově seřiditelné 9V	pro kovací drážku	100	<b>220219<sup>1</sup></b>	<b>201471<sup>1</sup></b>
		bez kovací drážky	100	<b>220220<sup>2</sup></b>	<b>203333<sup>2</sup></b>
	křídlové díly hloubkově seřiditelné 13V	bez kovací drážky	100	<b>208195<sup>2</sup></b>	<b>211008<sup>2</sup></b>
	rámové díly	4L 9V	100	<b>94484<sup>2</sup></b>	<b>204968<sup>2</sup></b>
		4L 13V	100	<b>357677<sup>2</sup></b>	
		Eurofalz FT18 9V	100	<b>94477<sup>2</sup></b>	<b>355796<sup>2</sup></b>
		Eurofalz FT20 9V	100	<b>98265<sup>2</sup></b>	<b>358861<sup>2</sup></b>
		Eurofalz FT24 13V	100	<b>359002<sup>2</sup></b>	<b>359572<sup>2*</sup></b>
		Euronut 6/8/4	100	<b>94478<sup>2</sup></b>	
		Euronut 7/8/4	100	<b>94479<sup>2</sup></b>	<b>201469<sup>2</sup></b>

<sup>1</sup> Vhodné MULTI POWER, INVISIBLE, TV, MULTI MAMMUT, DT, AS.

<sup>2</sup> Nevhodný pro VV!

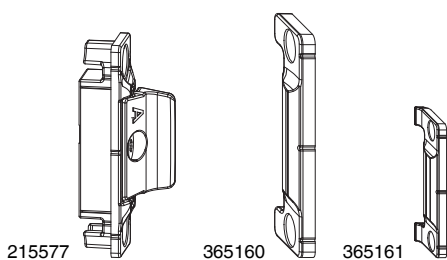

**7.10.4 Přítlačné panty skryté stranově seřiditelné**



**No**

**No**  
Tricoat

stříbrné	křídlové díly stranově seřiditelné pro dřevo	pro kovací drážku	100	<b>215577<sup>1</sup></b>	<b>219344<sup>1*</sup></b>
	křídlové díly stranově seřiditelné pro PVC	pro kovací drážku	100	<b>218543<sup>1,2</sup></b>	<b>226554<sup>1,2</sup></b>
stříbrné RAL 9022	rámové díly	Eurofalz FT18 9V	100	<b>365159<sup>1,3</sup></b>	
		Eurofalz FT20 9V	100	<b>365160<sup>1,3</sup></b>	
		Eurofalz FT24 13V	100	<b>365161<sup>1,3</sup></b>	
		Euronut 7/8/4	100	<b>367938<sup>1,3</sup></b>	
		Eurofalz FT30 13V	100	<b>367510<sup>1,3</sup></b>	
		Eurofalz FT24 13V	100	<b>367494<sup>1,3</sup></b>	
	rámové díly s pozičními čepy 8x4 mm	Eurofalz FT24 13V	100	<b>367494<sup>1,3</sup></b>	
	rámové díly s pozičními čepy 12x3 mm	Eurofalz FT24 13V	100	<b>367652<sup>1,3</sup></b>	

<sup>1</sup> Vhodné MULTI POWER, INVISIBLE, TV, MULTI MAMMUT, DT, AS.

<sup>2</sup> Rámové díly PVC viz profilové listy.

<sup>3</sup> V kombinaci s obj. č. 215577.

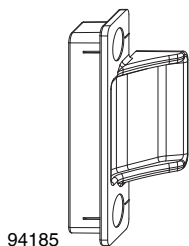

**K 7.10.5 Přítlačné panty skryté pro PVC**



**No**

**No**  
Tricoat

Silber	křídlové díly		100	<b>94185<sup>1,2</sup></b>	<b>355815<sup>1,2*</sup></b>
	křídlové díly s 5mm pozičními čepy		100	<b>354795<sup>1,2</sup></b>	

<sup>1</sup> Rámové díly PVC viz profilové listy.

<sup>2</sup> Vhodné MULTI POWER, INVISIBLE, TV, MULTI MAMMUT, DT, AS.

## 7.11 Krytky pro přítlačné panty

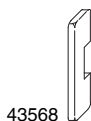

43568

7.11.1 Krytky pro přítlačné panty křídlové díly AS			N <sup>o</sup>	N <sup>o</sup> Tricoat
bílé RAL 9016	probarvené	100	41339	
stříbrné RAL 9022	probarvené	100	43568	
stříbrné	lakované	100	364107	
champagne	lakované	100	41699	
titan	lakované	100	40757	
světle bronzové	probarvené	100	41582	
krémově bílé RAL 9001	probarvené	100	41231	
hnědé F5	probarvené	100	41340	
Chrom-Look		100	44236	
Gold-Look		100	40553	

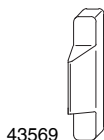

43569

7.11.2 Krytky pro přítlačné panty rámové díly AS			N <sup>o</sup>	N <sup>o</sup> Tricoat
bílé RAL 9016	probarvené	100	41342	
stříbrné RAL 9022	probarvené	100	43569	
stříbrné	lakované	100	364106	
champagne	lakované	100	41701	
titan	lakované	100	40756	
světle bronzové	probarvené	100	41583	
krémově bílé RAL 9001	probarvené	100	41233	
hnědé F5	probarvené	100	41343	
Chrom-Look		100	44235	
Gold-Look		100	40551	

MACO  
MULTI-MATIC



Otvírací závěsy  
a přítlačné panty



## 8 Ložiska nůžek

---

- 8.1 Ložiska nůžek PVC** \_\_\_\_\_
  - 8.1.1 Ložiska nůžek PVC
- 8.2 Ložiska nůžek AS** \_\_\_\_\_
  - 8.2.1 Ložiska nůžek AS
- 8.3 Úhelníky AS/PVC** \_\_\_\_\_
- 8.4 Úhelníky AS/PVC s předmontovanou bílou krytkou** \_\_\_\_\_
- 8.5 Ložiska nůžek DT** \_\_\_\_\_
  - 8.5.1 Ložiska nůžek DT130
  - 8.5.2 Ložiska nůžek DT160
  - 8.5.3 Úhelníky DTuni
- 8.6 Ložiska nůžek MULTI MAMMUT** \_\_\_\_\_
- 8.7 Ložiska nůžek TV pro oblouky** \_\_\_\_\_
- 8.8 Krytky** \_\_\_\_\_
  - 8.8.1 Krytky pro ložiska nůžek AS/DT130/PVC
  - 8.8.2 Krytky pro ložiska nůžek DT160
  - 8.8.3 Záslepky pro ložiska nůžek DT160
  - 8.8.4 Krytky pro úhelníky AS/PVC
  - 8.8.5 Krytky pro úhelníky DTuni
- 8.9 Příslušenství ložisek nůžek** \_\_\_\_\_
  - 8.9.1 Ložiskové čepy nůžek AS/DT/PVC
  - 8.9.2 Krytky proti nečistotám pro ložiska nůžek MULTI MAMMUT
  - 8.9.3 Příslušenství ložisek nůžek MULTI MAMMUT

## 8 Ložiska nůžek

### 8.1 Ložiska nůžek PVC

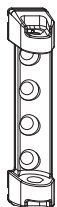

52480

K	8.1.1 Ložiska nůžek PVC		kg	kg	№	№ Tricoat
		s 7mm nosnými čepy	120	100	52481	201402*
	bílé RAL 9016	s 3mm pozičními čepy	100	100	204039	
		s 7mm nosnými čepy	120	100	204779	

### 8.2 Ložiska nůžek AS

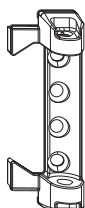

54694

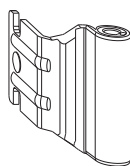

8.2.1	Ložiska nůžek AS		kg	kg	№	№ Tricoat
		12/20	120	50	54695	202519
	bílé RAL 9016	12/18	120	50	207876	
		12/20	120	50	207877	

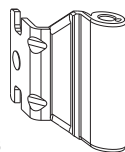

58477



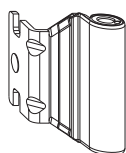

52486

<b>8.3 Úhelníky AS/PVC</b>				<b>No</b>	<b>No</b> Tricoat	
stříbrné	12/18-9	120	100	<b>54706</b>	<b>204564*</b>	
	12/18-10	120	100	<b>58619</b>	<b>204565*</b>	
	12/18-11	120	100	<b>206998</b>		
	12/18-13	120	100	<b>54709</b>	<b>204566*</b>	
	12/18-14	120	100	<b>56771</b>		
	12/18-26	80	100	<b>58477</b>		
	12/20-9	120	100	<b>52487</b>	<b>204570</b>	
	12/20-10	120	100	<b>52489</b>		
	12/20-11	120	100	<b>52488</b>		
	12/20-13	120	100	<b>52486</b>	<b>201403*</b>	
	12/20-14	120	100	<b>55359</b>	<b>204569*</b>	
	12/20-15	120	100	<b>55883</b>		
	12/20-26	80	100	<b>59469</b>		
	12/21-13	120	100	<b>58004</b>	<b>204573</b>	
	12/22-9	120	100	<b>55085</b>		
	12/22-13	120	100	<b>55051</b>	<b>204576</b>	
	bílé RAL 9016	12/18-9	120	100	<b>207882</b>	
		12/18-11	120	100	<b>207884</b>	
		12/18-13	120	100	<b>207885</b>	
		12/20-9	120	100	<b>207268</b>	
12/20-10		120	100	<b>207888</b>		
12/20-11		120	100	<b>207889</b>		
12/20-13		120	100	<b>206588</b>		
12/20-14		120	100	<b>207890</b>		
12/20-15		120	100	<b>207891</b>		
12/21-13		120	100	<b>207267</b>		
12/22-9		120	100	<b>207892</b>		
12/22-13		120	100	<b>207895</b>		



55009

<b>8.4 Úhelníky AS/PVC s předmontovanou bílou krytkou</b>				<b>No</b>	<b>No</b> Tricoat
stříbrné	12/20-9	120	100	<b>54799</b>	
	12/20-11	120	100	<b>201066</b>	
	12/20-13	120	100	<b>55009</b>	
	12/20-14	120	100	<b>201064</b>	
	12/21-13	120	100	<b>58006</b>	

## 8.5 Ložiska nůžek DT

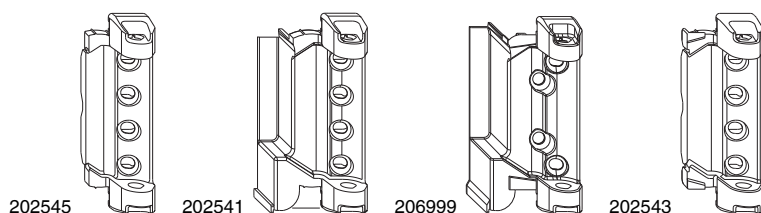

H 8.5.1 Ložiska nůžek DT130			kg	Cubes	No	No Tricoat	
stříbrné	4/15		130	50	202545 <sup>1</sup>		
	pravé 4/18-9		130	50	202541 <sup>1</sup>	206702 <sup>1</sup>	
	levé 4/18-9		130	50	202542 <sup>1</sup>	206703 <sup>1</sup>	
	pravé 4/18-13		130	50	206999 <sup>1</sup>	215019 <sup>1</sup>	
	levé 4/18-13		130	50	207000 <sup>1</sup>	215020 <sup>1</sup>	
	12/18		130	50	202543 <sup>1</sup>	206704 <sup>1*</sup>	
	12/20		130	50	202544 <sup>1</sup>	206705 <sup>1*</sup>	
	bílé RAL 9016	pravé 4/18-9		130	50	207878 <sup>1</sup>	
		levé 4/18-9		130	50	207879 <sup>1</sup>	
		pravé 4/18-13		130	50	207006 <sup>1</sup>	
levé 4/18-13			130	50	207007 <sup>1</sup>		
12/18			130	50	207880 <sup>1</sup>		
12/20			130	50	207881 <sup>1</sup>		

<sup>1</sup> Od 100 kg šikmě prošroubovat.

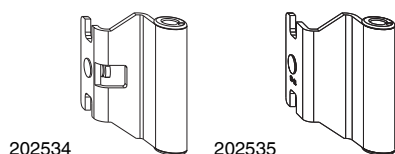



H 8.5.3 Úhelníky DTuni			kg	Cubes	No	No Tricoat	
stříbrné	4/15-9		160	50	202533 <sup>1</sup>	206696 <sup>1</sup>	
	4/18-9 a 12/18-9		160	50	202534 <sup>1</sup>	206697 <sup>1*</sup>	
	4/18-13 a 12/18-13		160	50	202535 <sup>1</sup>	206698 <sup>1*</sup>	
	12/18-11		160	50	202539 <sup>1</sup>	206701 <sup>1*</sup>	
	12/18-14		160	50	206718 <sup>1</sup>		
	12/20-9		160	50	202536 <sup>1</sup>	206699 <sup>1*</sup>	
	12/20-13		160	50	202537 <sup>1</sup>	206700 <sup>1*</sup>	
	bílé RAL 9016	4/15-9		160	100	207896 <sup>1</sup>	
		4/18-9 a 12/18-9		160	100	207897 <sup>1</sup>	
		4/18-13 a 12/18-13		160	100	207898 <sup>1</sup>	
12/18-11			160	50	208936 <sup>1</sup>		
12/18-14			160	50	215096 <sup>1</sup>		
12/20-9			160	100	207899 <sup>1</sup>		
12/20-13		160	50	212826 <sup>1</sup>			

<sup>1</sup> Pasuje k ložiskám nůžek DT130 a DT160.

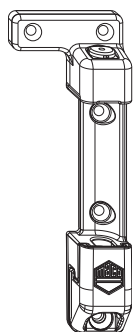



210600

8.6 Ložiska nůžek MULTI MAMMUT		 		№	№ Tricoat	
stříbrné	s 9mm nosnými čepy	pravé	220	20	<b>210600<sup>1</sup></b>	<b>223145<sup>1</sup></b>
		levé	220	20	<b>210601<sup>1</sup></b>	<b>223146<sup>1</sup></b>
bílé RAL 9016	s 9mm nosnými čepy	pravé	220	20	<b>212542<sup>1</sup></b>	
		levé	220	20	<b>212543<sup>1</sup></b>	

<sup>1</sup> Hloubka falcu min. 20 mm.

## 8.8 Krytky



42083

8.8.1 Krytky pro ložiska nůžek AS/DT130/PVC			N <sup>o</sup>	N <sup>o</sup> Tricoat
bílé RAL 9016	probarvené	100	42083 <sup>1</sup>	
stříbrné RAL 9022	probarvené	100	43761	
stříbrné	lakované	100	44290	
champagne	lakované	100	42103	
titan	lakované	100	42099	
světle bronzové	probarvené	100	42097	
krémově bílé RAL 9001	probarvené	100	42191	
hnědé F5	probarvené	100	42189	
Chrom-Look		100	44243	
Gold-Look		100	42098	
černé	probarvené	100	42190	

<sup>1</sup> K dispozici také jako velké balení po 500 ks., obj. č. 44284

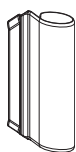

42084

8.8.4 Krytky pro úhelníky AS/PVC			N <sup>o</sup>	N <sup>o</sup> Tricoat
bílé RAL 9016	probarvené	100	42084 <sup>1</sup>	
stříbrné RAL 9022	probarvené	100	43760	
stříbrné	lakované	100	44291	
champagne	lakované	100	42108	
titan	lakované	100	42107	
světle bronzové	probarvené	100	42105	
krémově bílé RAL 9001	probarvené	100	42194	
hnědé F5	probarvené	100	42192	
Chrom-Look		100	44244	
Gold-Look		100	42106	
černé	probarvené	100	42193	

<sup>1</sup> K dispozici také jako velké balení po 500 ks., obj. č. 44284



354669

<span style="border: 1px solid black; border-radius: 50%; padding: 2px;">H</span> 8.8.5 Krytky pro úhelníky DTuni			<b>N<sup>o</sup></b>	<b>N<sup>o</sup></b> Tricoat
bílé RAL 9016	probarvené	100	<b>354669</b>	
stříbrné RAL 9022	probarvené	100	<b>354674</b>	
stříbrné	lakované	100	<b>360952</b>	
champagne	lakované	100	<b>354673</b>	
titan	lakované	100	<b>354672</b>	
světle bronzové	probarvené	100	<b>354670</b>	
krémově bílé RAL 9001	probarvené	100	<b>356597</b>	
hnědé F5	probarvené	100	<b>354675</b>	
Chrom-Look		100	<b>354676</b>	
Gold-Look		100	<b>354671</b>	
černé	probarvené	100	<b>356598</b>	

## 8.9 Příslušenství ložisek nůžek



94491

### 8.9.1 Ložiskové čepy nůžek AS/DT/PVC



**No**

**No**  
Tricoat

stříbrné

200

**94491**

**97553\***



364716

### 8.9.2 Krytky proti nečistotám pro ložiska nůžek MULTI MAMMUT



**No**

**No**  
Tricoat

bílé RAL 9016 probarvené

100

**364716**

stříbrné RAL 9022 probarvené

100

**364565**

titán probarvené

100

**367812**



364675

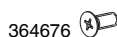

364676



362336

### 8.9.3 Příslušenství ložisek nůžek MULTI MAMMUT



**No**

**No**  
Tricoat

stříbrné zajištění ložiska nůžek pro ložiska Multi Mammut

20

**364675**

zapuštěné šrouby M5x12 pro zajištění ložiska nůžek

20

**364676**

bílé RAL 9016 zajištění ložiska nůžek pro ložiska Multi Mammut

20

**364677**

zapuštěné šrouby M5x12 pro zajištění ložiska nůžek

20

**364678**

bílé nástrčná pouzdra 10 mm Multi Mammut

50

**362336**



## 9 Spodní ložiska















---

- 9.1 Kombinace spodních ložisek a jejich křídlových dílů \_\_\_\_\_
- 9.2 Spodní ložiska PVC \_\_\_\_\_
- 9.3 Spodní ložiska AS \_\_\_\_\_
- 9.4 Spodní ložiska DT \_\_\_\_\_
- 9.5 Spodní ložiska MULTI MAMMUT \_\_\_\_\_
- 9.6 Spodní ložiska TV \_\_\_\_\_
- 9.7 Spodní ložiska INVISIBLE \_\_\_\_\_
- 9.8 Spodní ložiska MULTI POWER \_\_\_\_\_
- 9.9 Krytky \_\_\_\_\_
- 9.10 Příslušenství spodních ložisek \_\_\_\_\_

## 9 Spodní ložiska

### 9.1 Kombinace spodních ložisek a jejich křídlových dílů

#### 9.1.1 PVC

Spodní ložiska Křídlový díl spod. ložiska	Křídlový díl spod. ložiska PVC s 3 mm pozíci. čepy	Spodní ložiska s 7 mm nosnými čepy 3mm dlouhé	Spodní ložiska s 7 mm nosnými čepy 12mm 23 mm dlouhé	Spodní ložiska AS pro křídlový díl spod. ložiska AS / PVC	Spodní ložiska AS	Spodní ložiska INVISIBLE	Spodní ložiska MULTI POWER	Spodní ložiska MULTI MAMMUT
Křídlový díl spod. ložiska PVC s 3 mm pozíci. čepy 52478	 100 kg max. 2,4 m <sup>2</sup>	 100 kg max. 2,4 m <sup>2</sup>	 100 kg max. 2,4 m <sup>2</sup>	--	--	--	--	--
Křídlový díl spod. ložiska PVC 5 mm nosnými čepy 52479	 100 kg max. 3,0 m <sup>2</sup>	 100 kg max. 3,0 m <sup>2</sup>	 120 kg max. 3,0 m <sup>2</sup>	--	--	--	--	--
Falc. křídlový díl spod. ložiska AS /PVC bez UV	 100 kg max. 3,0 m <sup>2</sup>	 100 kg max. 3,0 m <sup>2</sup>	 120 kg max. 3,0 m <sup>2</sup>	 120 kg max. 3,0 m <sup>2</sup>	--	--	--	--
Falc. křídlový díl spod. ložiska AS /PVC s UV	--	--	--	--	 120 kg max. 3,0 m <sup>2</sup>	--	--	--
Falc. křídlový díl spod. ložiska INVISIBLE	--	--	--	--	--	 100 kg max. 2,4 m <sup>2</sup>	--	--
Falc. křídlový díl spod. ložiska MULTI POWER	--	--	--	--	--	--	 150 kg max. 3,0 m <sup>2</sup>	--
Falc. křídlový díl spod. ložiska MULTI MAMMUT	--	--	--	--	--	--	--	 180 kg max. 3,6 m <sup>2</sup>
Falc. křídlový díl spod. ložiska PVC MULTI MAMMUT	--	--	--	--	--	--	--	 180 kg max. 3,6 m <sup>2</sup>

\* Dodržujte omezení jednotlivých komponent na 80 kg!

Uvedené kombinace rohových ložisek / rohových závěsů lze kombinovat pouze s ložiskami nůžek stejného typu!

9.1.2 Dřevo

Spodní ložiska	Spodní ložiska AS	Spodní ložiska AS pro falc. kříd. díly spod. ložiska AS/PVC	Spodní ložiska DT130	Spodní ložiska DT160	Spodní ložiska TV	Spodní ložiska INVISIBLE	Spodní ložiska MULTI POWER	Spodní ložiska MULTI MAMMUT
<b>Kříd. díly spod. ložiska</b>								
Falc. kříd. díly spod. ložiska AS /PVC s UV	120 kg max. 3,0 m <sup>2</sup>	--	--	--	--	--	--	--
Falc. kříd. díly spod. ložiska AS /PVC bez UV	--	120 kg max. 3,0 m <sup>2</sup>	--	--	--	--	--	--
Falc. kříd. díly spod. ložiska DT bez UV	--	--	100 kg max. 3,0 m <sup>2</sup>	100 kg max. 3,0 m <sup>2</sup>	--	--	--	--
Falc. kříd. díly spod. ložiska DT 130 s UV	--	--	130 kg max. 3,0 m <sup>2</sup>	130 kg max. 3,0 m <sup>2</sup>	--	--	--	--
Falc. kříd. díly spod. ložiska DT 160 s UV	--	--	--	160 kg max. 3,0 m <sup>2</sup>	--	--	--	--
Falc. kříd. díly spod. ložiska TV	--	--	--	--	100 kg max. 2,4 m <sup>2</sup>	--	--	--
Falc. kříd. díly spod. ložiska INVISIBLE	--	--	--	--	--	100 kg max. 2,4 m <sup>2</sup>	--	--
Falc. kříd. díly spod. ložiska MULTI POWER	--	--	--	--	--	--	150 kg max. 3,0 m <sup>2</sup>	--
Falc. kříd. díly spod. ložiska MULTI MAMMUT	--	--	--	--	--	--	--	220 kg max. 3,6 m <sup>2</sup>
* Dodržujte omezení jednotlivých komponent na 80 kg!								
Uvedené kombinace rohových ložisek / rohových závěsů lze kombinovat pouze s ložiskami nůžek stejného typu!								

## 9.2 Spodní ložiska PVC

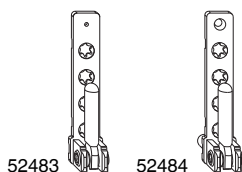

K 9.2.1 Spodní ložiska PVC		kg		No	No Tricoat
stříbrné	s 3 mm pozičními čepy	100	100	52483	201084*
	s 7 mm nosnými čepy 3 mm krátké	100	100	52485	204613*
	s 7 mm nosnými čepy 12 mm dlouhé	120	100	52764 <sup>1</sup>	204612 <sup>1</sup>
	s 7 mm nosnými čepy 23 mm dlouhé	120	100	52484 <sup>1</sup>	201401 <sup>1*</sup>
bílé RAL 9016	s 3 mm pozičními čepy	100	100	206802	
	s 7 mm nosnými čepy 3 mm krátké	100	100	206586	
	s 7 mm nosnými čepy 12 mm dlouhé	120	100	207902 <sup>1</sup>	
	s 7 mm nosnými čepy 23 mm dlouhé	120	100	207278 <sup>1</sup>	

<sup>1</sup> Od hmotnosti křídla nad 100 kg musí nosný čep přesahovat alespoň přes dvě profilové stěny.

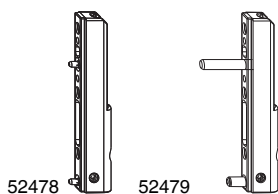

K 9.2.2 Křídlové díly spodního ložiska PVC		kg		No	No Tricoat
stříbrné	s 3 mm pozičními čepy	100	100	52478 <sup>1,2</sup>	202647 <sup>1,2*</sup>
	s 5 mm nosnými čepy 17 mm dlouhé	120	100	206196 <sup>1,3</sup>	
	s 5 mm nosnými čepy 23 mm dlouhé	120	100	52479 <sup>1,3</sup>	201400 <sup>1,3*</sup>
bílé RAL 9016	s 3 mm pozičními čepy	100	100	206848 <sup>1,2</sup>	
	s 5 mm nosnými čepy 23 mm dlouhé	120	100	206584 <sup>1,3</sup>	

<sup>1</sup> Podložky pro rohové závěsy viz příslušenství závěsu PVC.

<sup>2</sup> Maximální plocha křídla 2,4m<sup>2</sup>.

<sup>3</sup> Od hmotnosti křídla nad 100 kg musí nosný čep přesahovat alespoň přes dvě profilové stěny.



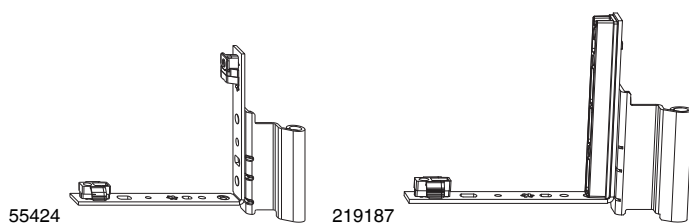

9.2.3 Křídlové díly falcového spodního ložiska AS/PVC bez ÜV			kg		No	No Tricoat	
Stříbrné	pravé	12/18-9	120	100	214391 <sup>1</sup>		
	levé	12/18-9	120	100	214392 <sup>1</sup>	215437 <sup>1</sup>	
	pravé	12/18-11	120	100	55424 <sup>1</sup>	204614 <sup>1*</sup>	
	levé	12/18-11	120	100	55425 <sup>1</sup>	204615 <sup>1*</sup>	
	pravé	12/18-13	120	100	59444 <sup>1</sup>	204616 <sup>1*</sup>	
	levé	12/18-13	120	100	59443 <sup>1</sup>	204617 <sup>1*</sup>	
	pravé	12/18-26	80	100	58475 <sup>1</sup>		
	levé	12/18-26	80	100	58476 <sup>1</sup>		
	pravé	12/20-9	120	100	54890 <sup>1</sup>	204620 <sup>1</sup>	
	levé	12/20-9	120	100	54891 <sup>1</sup>	204621 <sup>1</sup>	
	pravé	12/20-13	120	100	54892 <sup>1</sup>	201404 <sup>1*</sup>	
	levé	12/20-13	120	100	54893 <sup>1</sup>	201405 <sup>1*</sup>	
	pravé	12/20-14	120	100	212967 <sup>1</sup>		
	levé	12/20-14	120	100	212968 <sup>1</sup>		
	pravé	12/20-26	80	100	59916 <sup>1</sup>		
	levé	12/20-26	80	100	59917 <sup>1</sup>		
	RAL 9016 bílé	pravé	12/22-13	120	100	219187 <sup>1</sup>	
		levé	12/22-13	120	100	219188 <sup>1</sup>	
pravé		12/18-11	120	100	207916 <sup>1</sup>		
levé		12/18-11	120	100	207917 <sup>1</sup>		
pravé		12/20-9	120	100	207918 <sup>1</sup>		
levé		12/20-9	120	100	207919 <sup>1</sup>		
	pravé	12/20-13	120	100	207920 <sup>1</sup>		
	levé	12/20-13	120	100	207921 <sup>1</sup>		

<sup>1</sup> Nelze použít pro oblouková a šikmá okna, použití u profilových systémů s dorazovým těsněním konzultovat.

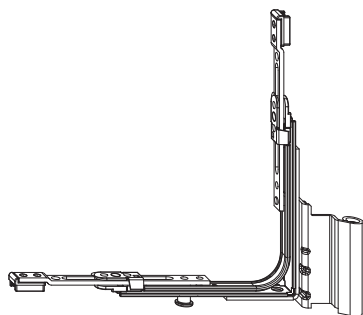

205664



9.2.4 Křídlové díly spodního ložiska AS/PVC EH bez UV				kg		No	No Tricoat
Stříbrné	s 1 i.S.	pravé	12/18-9	120	20	218155 <sup>1</sup>	
		levé	12/18-9	120	20	218156 <sup>1</sup>	
		pravé	12/18-13	120	20	218159 <sup>1</sup>	218988 <sup>1</sup>
		levé	12/18-13	120	20	218160 <sup>1</sup>	218989 <sup>1</sup>
		pravé	12/18-26	80	20	218161 <sup>1</sup>	
		levé	12/18-26	80	20	218162 <sup>1</sup>	
		pravé	12/20-9	120	20	218163 <sup>1</sup>	
		levé	12/20-9	120	20	218164 <sup>1</sup>	
		pravé	12/20-13	120	20	205664 <sup>1</sup>	207579 <sup>1</sup>
		levé	12/20-13	120	20	205665 <sup>1</sup>	207580 <sup>1</sup>
		pravé	12/20-26	80	20	218165 <sup>1</sup>	
		levé	12/20-26	80	20	218166 <sup>1</sup>	

<sup>1</sup> Použití pro oblouková nebo šikmá okna případně pro oblast bezpečnosti.



224282

224283

9.2.5 Rohový převod dvoudílný						No	No Tricoat
Stříbrné	horizontálně rozšířitelný			500 - 1.650	20	224282 <sup>1</sup>	
	vertikálně rozšířitelný			500 - 1.650	50	224283 <sup>2</sup>	



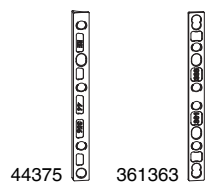

<sup>1</sup> Pro použití u obloukových oken doobjednat díl č. 224283.

<sup>2</sup> Pro použití u obloukových oken doobjednat díl č. 224282.

## 9.2.6 Příslušenství spodního ložiska PVC



44375 361363

9.2.6.1 Podložka pro křídlové díly spodního ložiska PVC					
Stříbrné	5°		100	<b>361364</b>	
bílé	5 mm	8,4	pravé	100	<b>44375</b>
			levé	100	<b>44374</b>
hnědé F5	5 mm	8,4		100	<b>361363</b>
			pravé	100	<b>363288</b>
			levé	100	<b>363289</b>

### 9.3 Spodní ložiska AS

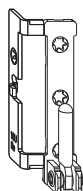

214104

9.3.1 Spodní ložiska AS pro falcový křídíl. díl spodního ložiska AS/PVC bez ÜV			kg		No	No Tricoat
Stříbrné	pravé	12/18	120	50	214104 <sup>1</sup>	218986 <sup>1</sup>
	levé	12/18	120	50	214105 <sup>1</sup>	218987 <sup>1</sup>
	pravé	12/20	120	50	214106 <sup>1</sup>	224271 <sup>1</sup>
	levé	12/20	120	50	214107 <sup>1</sup>	224272 <sup>1</sup>
RAL 9016 bílé	pravé	12/18	120	50	214112 <sup>1</sup>	
	levé	12/18	120	50	214113 <sup>1</sup>	
	pravé	12/20	120	50	214114 <sup>1</sup>	
	levé	12/20	120	50	214115 <sup>1</sup>	

<sup>1</sup> Použitelné pouze s falcovým křídlovým dílem ložiska ALU/PVC bez ÜV !

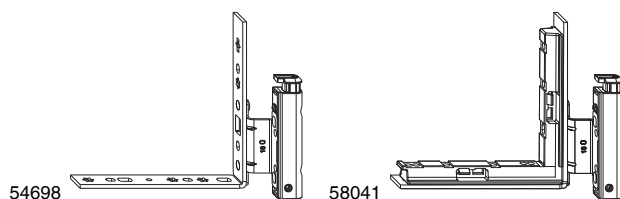

54698

58041

9.3.2 Křídlové díly spodního ložiska AS s ÜV			kg		No	No Tricoat			
Stříbrné	s ÜV	pravé	12/18-9	120	50	54698 <sup>1</sup>	204606 <sup>1</sup>		
		levé	12/18-9	120	50	54699 <sup>1</sup>	204607 <sup>1</sup>		
		pravé	12/18-11	120	50	206996 <sup>1</sup>			
		levé	12/18-11	120	50	206997 <sup>1</sup>			
		pravé	12/18-13	120	50	54700 <sup>1</sup>	204608 <sup>1</sup>		
		levé	12/18-13	120	50	54701 <sup>1</sup>	204603 <sup>1</sup>		
		pravé	12/20-9	120	50	54702 <sup>1</sup>			
		levé	12/20-9	120	50	54703 <sup>1</sup>			
		pravé	12/20-13	120	50	54704 <sup>1</sup>	202520 <sup>1</sup>		
		levé	12/20-13	120	50	54705 <sup>1</sup>	202521 <sup>1</sup>		
		přemontované podložky pro křídíl.díl spod.ložiska		pravé	12/18-9	120	50	58041 <sup>1,2</sup>	
				levé	12/18-9	120	50	58042 <sup>1,2</sup>	
				pravé	12/20-13	120	50	222168 <sup>1,2</sup>	
				levé	12/20-13	120	50	222169 <sup>1,2</sup>	
RAL 9016 bílé	s ÜV	pravé	12/18-9	120	50	207922 <sup>1</sup>			
		levé	12/18-9	120	50	207923 <sup>1</sup>			
		pravé	12/18-11	120	50	207924 <sup>1</sup>			
		levé	12/18-11	120	50	207925 <sup>1</sup>			
		pravé	12/18-13	120	50	207926 <sup>1</sup>			
		levé	12/18-13	120	50	207927 <sup>1</sup>			
		pravé	12/20-9	120	50	207928 <sup>1</sup>			
		levé	12/20-9	120	50	207929 <sup>1</sup>			
		pravé	12/20-13	120	50	207930 <sup>1</sup>			
		levé	12/20-13	120	50	207931 <sup>1</sup>			
		přemontované podložky pro křídíl.díl spod.ložiska		pravé	12/20-13	120	50	207932 <sup>1,2</sup>	
				levé	12/20-13	120	50	207933 <sup>1,2</sup>	

<sup>1</sup> Použití u profilových systémů s dorazovým těsněním konzultovat.

<sup>2</sup> Není vhodný pro oblouková a šikmá okna.

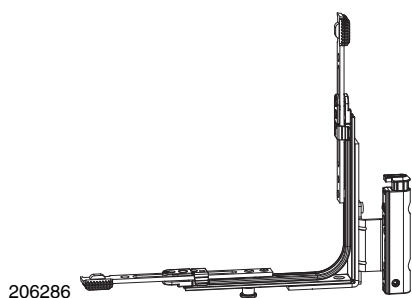

206286

9.3.3 Křídlové díly spodního ložiska AS s ÜV EH				kg	kg	No	No Tricoat
Stříbrné	s 1 i.S.	pravé	12/18-9	120	20	206286 <sup>1</sup>	
		levé	12/18-9	120	20	206287 <sup>1</sup>	
		pravé	12/18-13	120	20	206288 <sup>1</sup>	207585 <sup>1</sup>
		levé	12/18-13	120	20	206289 <sup>1</sup>	207586 <sup>1</sup>
		pravé	12/20-9	120	20	206290 <sup>1</sup>	
		levé	12/20-9	120	20	206291 <sup>1</sup>	207588 <sup>1</sup>
		pravé	12/20-13	120	20	206292 <sup>1</sup>	
		levé	12/20-13	120	20	206293 <sup>1</sup>	

<sup>1</sup> Použití pro oblouková nebo šikmá okna případně pro oblast bezpečnosti.

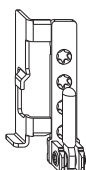

54690

9.3.4 Spodní ložiska AS pro křídli. díl spodního ložiska AS s ÜV				kg	kg	No	No Tricoat
Stříbrné	pravé	12/18	120	50	54690 <sup>1</sup>	204604 <sup>1</sup>	
	levé	12/18	120	50	54691 <sup>1</sup>	204605 <sup>1</sup>	
	pravé	12/20	120	50	54692 <sup>1</sup>	202522 <sup>1</sup>	
	levé	12/20	120	50	54693 <sup>1</sup>	202523 <sup>1</sup>	
RAL 9016 bílé	pravé	12/18	120	50	207904 <sup>1</sup>		
	levé	12/18	120	50	207905 <sup>1</sup>		
	pravé	12/20	120	50	207906 <sup>1</sup>		
	levé	12/20	120	50	207907 <sup>1</sup>		

<sup>1</sup> Použitelné pouze s křídli. dílem spodního ložiska AS s ÜV!

## 9.4 Spodní ložiska DT

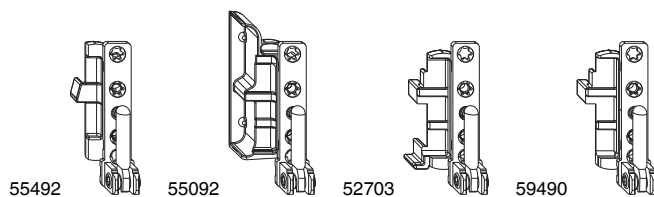

H	9.4.1 Spodní ložiska DT130			kg		No		No			
				kg		Tricoat		Tricoat			
Stříbrné		pravé	4/15	130	50	55492 <sup>1</sup>					
		levé	4/15	130	50	55493 <sup>1</sup>					
		pravé	4/18	130	50	55092 <sup>1,2,3</sup>	204785 <sup>1,2,3</sup>				
		levé	4/18	130	50	55093 <sup>1,2,3</sup>	204786 <sup>1,2,3</sup>				
		pravé	12/18	130	50	52703 <sup>1</sup>	201601 <sup>1*</sup>				
		levé	12/18	130	50	52704 <sup>1</sup>	202311 <sup>1*</sup>				
		pravé	12/20	130	50	54726 <sup>1</sup>	204787 <sup>1*</sup>				
		levé	12/20	130	50	54727 <sup>1</sup>	204788 <sup>1*</sup>				
		pro balkonové dveře	pravé	12/18	130	50	59490 <sup>1</sup>	204125 <sup>1*</sup>			
		levé	12/18	130	50	59491 <sup>1</sup>	204126 <sup>1*</sup>				
		pravé	12/20	130	50	58601 <sup>1</sup>	213221 <sup>1</sup>				
		levé	12/20	130	50	58602 <sup>1</sup>	213222 <sup>1</sup>				
		RAL 9016 bílé		pravé	4/15	130	50	207908 <sup>1</sup>			
				levé	4/15	130	50	207909 <sup>1</sup>			
pravé	4/18			130	50	207910 <sup>1,4</sup>					
levé	4/18			130	50	207911 <sup>1,4</sup>					
pravé	12/18			130	50	207912 <sup>1</sup>					
levé	12/18			130	50	207913 <sup>1</sup>					
pravé	12/20			130	50	207914 <sup>1</sup>					
levé	12/20			130	50	207915 <sup>1</sup>					

<sup>1</sup> Při hmotnosti křídla přes 100 kg nebo hustotě pod 0,62 g/cm<sup>3</sup> zašroubovat lícovaně vruty 4 x 40 mm pod spodní ložisko!

<sup>2</sup> Pro frézovací hloubku 24,5mm použít podložku 360464 !

<sup>3</sup> Pro frézovací hloubku 22mm použít podložku 366541 !

<sup>4</sup> Pro frézovací hloubku 24,5mm použít podložku 360465 !

9.4.3 Křídlové díly spodního ložiska DT

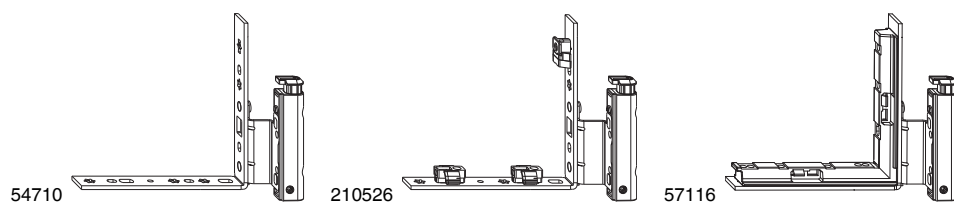

9.4.3.1 Křídlové díly spodního ložiska DT130 s ŮV





No

No  
Tricoat

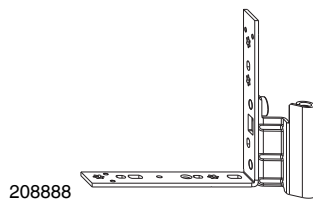
Stříbrné	s ŮV			kg		No	No Tricoat
		pravé	4/15-9	130	50	55494	
		levé	4/15-9	130	50	55495	
		pravé	4/18-9	130	50	220048	204797
		levé	4/18-9	130	50	220051	204798
		pravé	4/18-13	130	50	207870	
		levé	4/18-13	130	50	207871	
		pravé	12/18-9	130	50	54710	201602*
		levé	12/18-9	130	50	54711	202310*
		pravé	12/18-13	130	50	55452	204808*
		levé	12/18-13	130	50	55453	204809*
		pravé	12/20-9	130	50	54712	204810*
		levé	12/20-9	130	50	54713	204811*
		pravé	12/20-13	130	50	220045	204812*
		levé	12/20-13	130	50	220046	204813*
	s ŮV pro kovací drážku	pravé	4/18-9	130	50	210526	
		levé	4/18-9	130	50	210527	
		pravé	4/18-13	130	50	210524	
		levé	4/18-13	130	50	210525	
	s ŮV a předmontovanými podložkami	pravé	12/18-9	130	50	57116	218938
		levé	12/18-9	130	50	57117	218937
		pravé	12/18-11	130	50	201016	204799*
		levé	12/18-11	130	50	201017	204800*
		pravé	12/18-13	130	50	209594	211096
		levé	12/18-13	130	50	209595	211097
		pravé	12/20-13	130	50	214774	
		levé	12/20-13	130	50	214775	
		pravé	12/18-14	130	50	206994	
		levé	12/18-14	130	50	206995	
RAL 9016 bílé	s ŮV	pravé	4/15-9	130	50	207940	
		levé	4/15-9	130	50	207941	
		pravé	4/18-9	130	50	207942	
		levé	4/18-9	130	50	207943	
		pravé	4/18-13	130	50	207872	
		levé	4/18-13	130	50	207873	
		pravé	12/18-9	130	50	207944	
		levé	12/18-9	130	50	207945	
		pravé	12/18-13	130	50	207946	
		levé	12/18-13	130	50	207947	
		pravé	12/20-9	130	50	207948	
		levé	12/20-9	130	50	207949	
		pravé	12/20-13	130	50	213683	
		levé	12/20-13	130	50	213684	
	s ŮV pro kovací drážku	pravé	4/18-13	130	50	218074	
		levé	4/18-13	130	50	218075	
	s ŮV a předmontovanými podložkami	pravé	12/18-11	130	50	209500	
		levé	12/18-11	130	50	209501	
		pravé	12/18-13	130	50	211720	
		levé	12/18-13	130	50	211721	



<b>H 9.4.3.3 Křídlové díly spodního ložiska DT bez ÚV</b>		 		<b>N<sup>o</sup></b>	<b>N<sup>o</sup></b> Tricoat	
Stříbrné	pravé 4/18-9	100	50	<b>55097</b>		
	levé 4/18-9	100	50	<b>55098</b>		
	pravé 12/18-9	100	50	<b>52706</b>	<b>204791</b>	
	levé 12/18-9	100	50	<b>52707</b>	<b>204792</b>	
	pravé 12/18-13	100	50	<b>208888<sup>1</sup></b>		
	levé 12/18-13	100	50	<b>208889<sup>1</sup></b>		
	pravé 12/20-9	100	50	<b>54728</b>	<b>204793</b>	
	levé 12/20-9	100	50	<b>54729</b>	<b>204794</b>	
	pravé 12/20-13	100	50	<b>212209<sup>1</sup></b>	<b>224634<sup>1</sup></b>	
	levé 12/20-13	100	50	<b>212210<sup>1</sup></b>	<b>224635<sup>1</sup></b>	
	RAL 9016 bílé	pravé 4/18-9	100	50	<b>207934</b>	
		levé 4/18-9	100	50	<b>207935</b>	
pravé 12/18-9		100	50	<b>207936</b>		
levé 12/18-9		100	50	<b>207937</b>		
pravé 12/20-9		100	50	<b>207938</b>		
levé 12/20-9		100	50	<b>207939</b>		

<sup>1</sup> Při použití podložky pod křídlový pant č. 44234 není vyžadován svislý otvor pro šroub.



54684

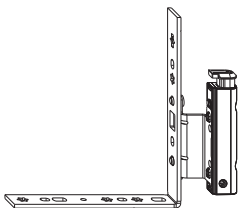

**H 9.4.3.4 Křídlové díly spodního ložiska DT130 pro dveře s ÜV**



**No**

**No**  
Tricoat

Stříbrné	pro balkonové dveře s ÜV						
		pravé	12/18-9	130	50	<b>54684</b>	<b>204122</b>
		levé	12/18-9	130	50	<b>54685</b>	<b>204123</b>
		pravé	12/18-13	130	50	<b>209411</b>	<b>214059*</b>
		levé	12/18-13	130	50	<b>209412</b>	<b>214060*</b>
		pravé	12/20-9	130	50	<b>54688</b>	<b>212588</b>
		levé	12/20-9	130	50	<b>54689</b>	<b>213223</b>
		pravé	12/20-13	130	50	<b>209413</b>	
		levé	12/20-13	130	50	<b>209414</b>	

57232

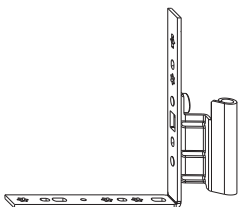

**H 9.4.3.6 Křídlové díly spodního ložiska DT pro dveře bez ÜV**



**No**



**No**  
Tricoat

Stříbrné	pro balkonové dveře						
		pravé	12/18-9	100	50	<b>57232</b>	
		levé	12/18-9	100	50	<b>57233</b>	
		pravé	12/18-13	100	50	<b>209407<sup>1</sup></b>	
		levé	12/18-13	100	50	<b>209408<sup>1</sup></b>	
		pravé	12/20-13	100	50	<b>209409<sup>1</sup></b>	
		levé	12/20-13	100	50	<b>209410<sup>1</sup></b>	

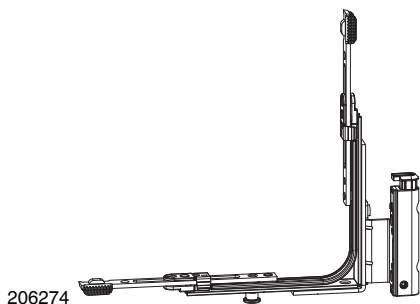
<sup>1</sup> Při použití podložky pod křídlový pant č. 44234 není vyžadován svislý otvor pro šroub.





206274

<b>H 9.4.3.7 Křídlové díly spodního ložiska DT s UV EH</b>						<b>No</b>	<b>No</b> Tricoat
Stříbrné	s 1 i.S.	pravé	4/15-9	130	20	<b>224284<sup>1</sup></b>	
		levé	4/15-9	130	20	<b>224285<sup>1</sup></b>	
		pravé	4/18-13	130	20	<b>214908<sup>1</sup></b>	
		levé	4/18-13	130	20	<b>214910<sup>1</sup></b>	
		pravé	12/18-9	130	20	<b>206274<sup>1</sup></b>	<b>207593<sup>1</sup></b>
		levé	12/18-9	130	20	<b>206275<sup>1</sup></b>	<b>207594<sup>1</sup></b>
		pravé	12/18-11	130	20	<b>207065<sup>1</sup></b>	<b>207595<sup>1</sup></b>
		levé	12/18-11	130	20	<b>207066<sup>1</sup></b>	<b>207596<sup>1</sup></b>
		pravé	12/18-13	130	20	<b>206276<sup>1</sup></b>	<b>208315<sup>1</sup></b>
		levé	12/18-13	130	20	<b>206277<sup>1</sup></b>	<b>208316<sup>1</sup></b>
		pravé	12/20-9	130	20	<b>206278<sup>1</sup></b>	<b>207597<sup>1</sup></b>
		levé	12/20-9	130	20	<b>206279<sup>1</sup></b>	<b>207598<sup>1</sup></b>
		pravé	12/20-13	130	20	<b>206280<sup>1</sup></b>	<b>207599<sup>1</sup></b>
		levé	12/20-13	130	20	<b>206281<sup>1</sup></b>	<b>207600<sup>1</sup></b>

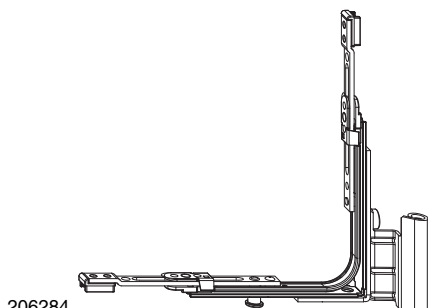
<sup>1</sup> Použití pro oblouková nebo šikmá okna případně pro oblast bezpečnosti.



206284



<b>H 9.4.3.8 Křídlové díly spodního ložiska DT bez UV EH</b>						<b>No</b>	<b>No</b> Tricoat
Stříbrné	s 1 i.S.	pravé	4/18-9	100	20	<b>206284<sup>1</sup></b>	
		levé	4/18-9	100	20	<b>206285<sup>1</sup></b>	
		pravé	12/18-9	100	20	<b>208773<sup>1</sup></b>	
		levé	12/18-9	100	20	<b>208774<sup>1</sup></b>	
		pravé	12/18-13	100	20	<b>208793<sup>1</sup></b>	<b>217668<sup>1</sup></b>
		levé	12/18-13	100	20	<b>208794<sup>1</sup></b>	<b>217669<sup>1</sup></b>
		pravé	12/20-9	100	20	<b>208775<sup>1</sup></b>	
			12/20-13	100	20	<b>208795<sup>1</sup></b>	
		levé	12/20-13	100	20	<b>208796<sup>1</sup></b>	

<sup>1</sup> Použití pro oblouková nebo šikmá okna případně pro oblast bezpečnosti.

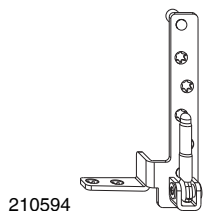
## 9.5 Spodní ložiska MULTI MAMMUT



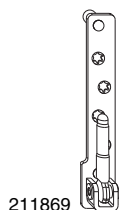

210594

<b>H 9.5.1 Spodní ložiska DŘEVO MULTI MAMMUT</b>						<b>No</b>	<b>No</b> Tricoat
Stříbrné	s 9 mm nosnými čepy	pravé	12/18	220	20	<b>210594</b>	<b>223053</b>
		levé	12/18	220	20	<b>210595</b>	<b>223054</b>
		pravé	12/20	220	20	<b>210605</b>	<b>223055</b>
		levé	12/20	220	20	<b>210606</b>	<b>223056</b>
RAL 9016 bílé	s 9 mm nosnými čepy	pravé	12/18	220	20	<b>222500</b>	
		levé	12/18	220	20	<b>222501</b>	
		pravé	12/20	220	20	<b>222502</b>	
		levé	12/20	220	20	<b>222503</b>	



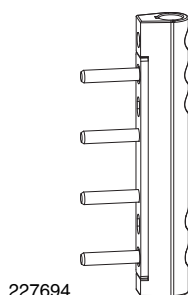

211869

<b>K 9.5.2 Spodní ložiska PVC MULTI MAMMUT</b>						<b>No</b>	<b>No</b> Tricoat
Stříbrné	s 9 mm nosnými čepy	pravé	12/18 12/20	180	20	<b>211869</b>	<b>217765</b>
		levé	12/18 12/20	180	20	<b>211870</b>	<b>217766</b>
RAL 9016 bílé	s 9 mm nosnými čepy	pravé	12/18 12/20	180	20	<b>212540</b>	
		levé	12/18 12/20	180	20	<b>212541</b>	



227694

<b>K 9.5.3 Křídlové díly spodního ložiska PVC MULTI MAMMUT</b>						<b>No</b>	<b>No</b> Tricoat
Stříbrné	s 5mm nosnými čepy 23 mm dlouhé			180	20	<b>227694</b>	<b>227696</b>
RAL 9016 bílé	s 5mm nosnými čepy 23 mm dlouhé			180	20	<b>227695</b>	

210613

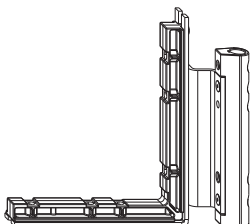

<b>9.5.4 Křídlové díly falcového spodního ložiska MULTI MAMMUT</b>						<b>No</b>	<b>No</b> Tricoat
Stříbrné	předmontované podložky pro křídíl.díl spod.ložiska	pravé	12/18-9	220	20	<b>210613</b>	<b>223059</b>
		levé	12/18-9	220	20	<b>210614</b>	<b>223060</b>
		pravé	12/18-13	220	20	<b>210611</b>	<b>223057</b>
		levé	12/18-13	220	20	<b>210612</b>	<b>223058</b>
		pravé	12/20-9	220	20	<b>210617</b>	<b>223063</b>
		levé	12/20-9	220	20	<b>210618</b>	<b>223064</b>
		pravé	12/20-13	220	20	<b>210615</b>	<b>223061</b>
		levé	12/20-13	220	20	<b>210616</b>	<b>223062</b>
RAL 9016 bílé	předmontované podložky pro křídíl.díl spod.ložiska	pravé	12/18-9	220	20	<b>222506</b>	
		levé	12/18-9	220	20	<b>222507</b>	
		pravé	12/18-13	220	20	<b>222504</b>	
		levé	12/18-13	220	20	<b>222505</b>	
		pravé	12/20-9	220	20	<b>222510</b>	
		levé	12/20-9	220	20	<b>222511</b>	
		pravé	12/20-13	220	20	<b>222508</b>	
		levé	12/20-13	220	20	<b>222509</b>	

363306



362336



<b>9.5.5 Příslušenství spodních ložisek MULTI MAMMUT</b>					<b>No</b>	<b>No</b> Tricoat
Stříbrné	nástrčné díly pro křídíl.díl spod. ložiska Multi Mammut	2 mm		50	<b>363306</b>	
		3 mm		50	<b>363307</b>	
bílé	nástrčná pouzdra 10 mm Multi Mammut			50	<b>362336</b>	

## 9.7 Spodní ložiska INVISIBLE

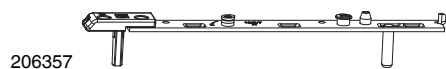

206357

9.7.1 Spodní ložiska INVISIBLE					kg		No	No Tricoat
Stříbrné	šroubovací osa 12 mm	pravé	9V	DŘEVO FT18	80	20	212659	
		levé	9V	DŘEVO FT18	80	20	212660	
	šroubovací osa 13 mm	pravé	9V	DŘEVO FT20	100	20	206357	
		levé	9V	DŘEVO FT20	100	20	206358	

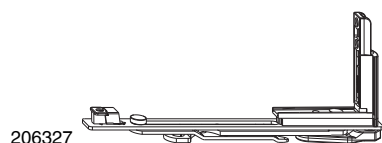

206327

9.7.2 Křídlové díly spod.ložiska VV INVISIBLE					kg		No	No Tricoat
Stříbrné	DŘEVO FT18	pravé	9V		80	20	212663	
		levé	9V		80	20	212664	
	DŘEVO FT20	pravé	9V		100	20	206327	
		levé	9V		100	20	206328	



465315

9.7.3 Příslušenství VV INVISIBLE							No	No Tricoat
bílé	nástrčná pouzdra 8 mm Invisible				400		465315	

## 9.8 Spodní ložiska MULTI POWER

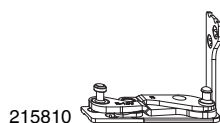

H	9.8.1 Spodní ložiska DŘEVO Multi Power			kg	Cubes	No	No Tricoat
Stříbrné		pravé	DŘEVO FT24 9V	150	20	215812 <sup>1</sup>	218883 <sup>1*</sup>
		levé	DŘEVO FT24 9V	150	20	215813 <sup>1</sup>	218884 <sup>1*</sup>
		pravé	DŘEVO FT24 13V	150	20	215810 <sup>1</sup>	218885 <sup>1*</sup>
		levé	DŘEVO FT24 13V	150	20	215811 <sup>1</sup>	218886 <sup>1*</sup>
		pravé	DŘEVO FT30 13V	150	20	214252 <sup>1</sup>	218887 <sup>1*</sup>
		levé	DŘEVO FT30 13V	150	20	214253 <sup>1</sup>	218888 <sup>1*</sup>

<sup>1</sup> Od 100kg zpevnit spodní ložisko podpůrnou hmoždinkou 36668.

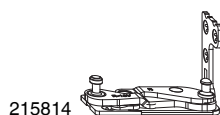

K	9.8.2 Spodní ložiska PVC MULTI POWER			kg	Cubes	No	No Tricoat
Stříbrné		pravé	PVC FT30 9V	150	20	215816	
		levé	PVC FT30 9V	150	20	215817	
		pravé	PVC FT30 13V	150	20	215814	218891*
		levé	PVC FT30 13V	150	20	215815	218892*

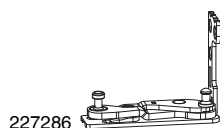

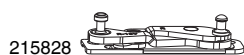

K	9.8.3 Spodní ložiska PVC MULTI POWER pro prahy			kg	Cubes	No	No Tricoat
Stříbrné	pro prahy	pravé	13V PVC	150	20	227286 <sup>1</sup>	
		levé	13V PVC	150	20	227287 <sup>1</sup>	

<sup>1</sup> Dodržujte pokyny pro instalaci a omezení u prahů typu Grundmeier KG Combi, Eifel TB a Profine A075 nebo A076!





H	9.8.4 Spodní ložiska 3kř. DŘEVO Multi Power			kg	Cubes	No	No Tricoat
Stříbrné		pravé	DŘEVO FT24 9V	80	20	215830	218893
		levé	DŘEVO FT24 9V	80	20	215831	218894
		pravé	DŘEVO FT24 13V	80	20	215828	218895
		levé	DŘEVO FT24 13V	80	20	215829	218896

215832 

<b>9.8.5 Spodní ložiska 3kř. PVC Multi Power</b>					<b>No</b>	<b>No</b> Tricoat
Stříbrné	pravé	PVC FT30 9V	80	20	<b>215834</b>	
	levé	PVC FT30 9V	80	20	<b>215835</b>	
	pravé	PVC FT30 13V	80	20	<b>215832</b>	<b>218899</b>
	levé	PVC FT30 13V	80	20	<b>215833</b>	<b>218900</b>



215804 



<b>9.8.6 Křídlové díly spodního ložiska Multi Power</b>					<b>No</b>	<b>No</b> Tricoat
Stříbrné	pravé	9V	150	20	<b>215806</b>	<b>218879*</b>
	levé	9V	150	20	<b>215807</b>	<b>218880*</b>
	pravé	13V	150	20	<b>215804</b>	<b>218881*</b>
	levé	13V	150	20	<b>215805</b>	<b>218882*</b>

### 9.8.7 Přenašeč zatížení MULTI POWER

105336 

105338 

<b>9.8.7.1 Přenašeč zatížení MULTI POWER</b>					<b>No</b>	<b>No</b> Tricoat
Stříbrné	pravé	FT24	180	10	<b>105336</b>	<b>105574</b>
	levé	FT24	180	10	<b>105339</b>	<b>105787</b>
	pravé	FT30	180	10	<b>105338</b>	<b>105575</b>
	levé	FT30	180	10	<b>105337</b>	<b>105788</b>

371446  371447  371632 

<b>9.8.7.2 Příslušenství pro přenašeč zatížení MULTI POWER</b>				<b>No</b>	<b>No</b> Tricoat
Těsnění pro přenašeč Multi Power			500	<b>371446</b>	
Montážní pomůcka pro přenašeč Multi Power			50	<b>371447</b>	
Fixační díl pro přenašeč Multi Power			50	<b>371632</b>	

### 9.8.8 Podložky MULTI POWER

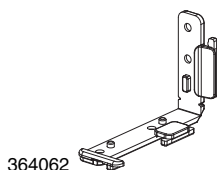





364062

<b>K 9.8.8.1 Podložky MULTI POWER pro PVC profily</b>				<b>N<sub>0</sub></b>	<b>N<sub>0</sub></b> Tricoat	
Šedá F1	Typ01 pro Multi Power	Aluplast AD 2000, Veka Softline 70 AD + MD + Topline + Swingline, Brüggmann AD + MD, Alphacan System Alpha 70 + 80, Schüco Corona CT70 / SI 82, Salamander bluEvolution 82 AD + MD	Ecklager levé / Scherenlager pravé	100	<b>364063</b>	
			Ecklager pravé / Scherenlager levé	100	<b>364062</b>	
Typ02 pro Multi Power	Aluplast AD 4000, Aluplast MD 5000 + 6000 + 8000, Schüco Corona AS	Ecklager levé / Scherenlager pravé	100	<b>364065</b>		
		Ecklager pravé / Scherenlager levé	100	<b>364064</b>		
Typ03 pro Multi Power	Salamander bluEvolution 92 + System 76 MD, Gromathic AD 3100	Ecklager levé / Scherenlager pravé	100	<b>364067</b>		
		Ecklager pravé / Scherenlager levé	100	<b>364066</b>		
Typ04 pro Multi Power	Rehau S730 + Brilliant Design AD + Clima Design, Kompen Termoline	Ecklager levé / Scherenlager pravé	100	<b>364069</b>		
		Ecklager pravé / Scherenlager levé	100	<b>364068</b>		
Typ05 pro Multi Power	Profine Trocal Innonova 70 A3/A5/M5	Ecklager levé / Scherenlager pravé	100	<b>364071</b>		
		Ecklager pravé / Scherenlager levé	100	<b>364070</b>		
Typ06 pro Multi Power	Gealan S7000 + S8000 + S9000	Ecklager levé / Scherenlager pravé	100	<b>364073</b>		
		Ecklager pravé / Scherenlager levé	100	<b>364072</b>		
Typ07 pro Multi Power	Salamander 2D + 3D + MD + Streamline 76	Ecklager levé / Scherenlager pravé	100	<b>364075</b>		
		Ecklager pravé / Scherenlager levé	100	<b>364074</b>		
Typ08 pro Multi Power	Rehau Geneo MD + Brilliant Design MD + Thermo Design	Ecklager levé / Scherenlager pravé	100	<b>364077</b>		
		Ecklager pravé / Scherenlager levé	100	<b>364076</b>		
Typ09 pro Multi Power	Profine Trocal System 88 + Innonova 2000	Ecklager levé / Scherenlager pravé	100	<b>364175<sup>1</sup></b>		
		Ecklager pravé / Scherenlager levé	100	<b>364174<sup>1</sup></b>		
Typ10 pro Multi Power	Aluplast Energeto 5000 + 8000	Ecklager levé / Scherenlager pravé	100	<b>364177</b>		
		Ecklager pravé / Scherenlager levé	100	<b>364176</b>		
Typ11 pro Multi Power	Inoutic AD	Ecklager levé / Scherenlager pravé	100	<b>364179</b>		
		Ecklager pravé / Scherenlager levé	100	<b>364178</b>		
Typ12 pro Multi Power	Inoutic Prestige MD	Ecklager levé / Scherenlager pravé	100	<b>364181<sup>1</sup></b>		
		Ecklager pravé / Scherenlager levé	100	<b>364180<sup>1</sup></b>		
Typ13 pro Multi Power	Kömmerling Eurofutur AD + MD + 3S + MPF, KBE 70 AD + MD	Ecklager levé / Scherenlager pravé	100	<b>366340</b>		
		Ecklager pravé / Scherenlager levé	100	<b>366339</b>		
Typ14 pro Multi Power	KB07 KBE 70 AD, KB08 KBE 70 MD, KB13 KBE System 88, Trocal 76 AD; Deceuninck Zendow	Ecklager levé / Scherenlager pravé	100	<b>367263</b>		
		Ecklager pravé / Scherenlager levé	100	<b>367262</b>		
Typ15 pro Multi Power	Wymar 3000 AD + MD	Ecklager levé / Scherenlager pravé	100	<b>367848</b>		
		Ecklager pravé / Scherenlager levé	100	<b>367847</b>		
Typ16 pro Multi Power	Swish 24-7 / Profile 22	Ecklager levé / Scherenlager pravé	100	<b>368311</b>		
		Ecklager pravé / Scherenlager levé	100	<b>368310</b>		
Typ17 pro Multi Power	Deceuninck Zendow Kämpfer; Roplasto	Ecklager levé / Scherenlager pravé	100	<b>369288</b>		
		Ecklager pravé / Scherenlager levé	100	<b>369287</b>		
Typ18 pro Multi Power	Eurocell TBT	Ecklager levé / Scherenlager pravé	100	<b>370031</b>		
		Ecklager pravé / Scherenlager levé	100	<b>370030</b>		
Typ19 pro Multi Power	Profile 22 Optima	Ecklager levé / Scherenlager pravé	100	<b>370466</b>		
		Ecklager pravé / Scherenlager levé	100	<b>370465</b>		
Typ20 pro Multi Power	Eurocell und Eurologic 70	Ecklager levé / Scherenlager pravé	100	<b>370600</b>		
		Ecklager pravé / Scherenlager levé	100	<b>370599</b>		
Typ21 pro Multi Power	HL Plastics Liniar	Ecklager levé / Scherenlager pravé	100	<b>370602</b>		
		Ecklager pravé / Scherenlager levé	100	<b>370601</b>		
Typ22 pro Multi Power	Synseal Synerjy	Ecklager levé / Scherenlager pravé	100	<b>370506</b>		
		Ecklager pravé / Scherenlager levé	100	<b>370505</b>		

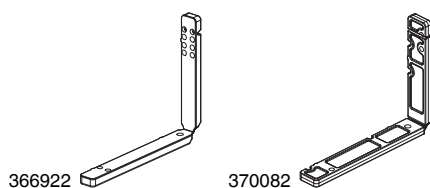
<sup>1</sup> Použijte rohové ložisko MULTI POWER dřevo FT24









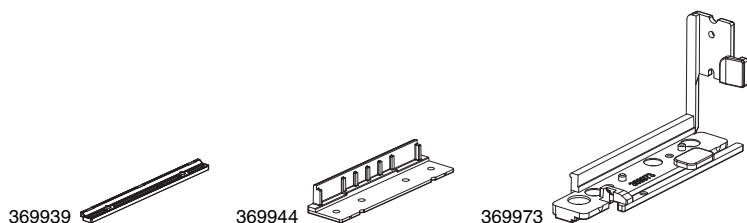

9.8.8.2 Podložky MULTI POWER pro Alu-Profile						
Šedá RAL 9022	čep 10/14	Heroal	Rohové ložisko spodní a horní Multi Power	100	<b>366922<sup>1</sup></b>	
F1	čep 14/18	Aluprof, Alumil, Aliplast, Blyweert, Ponzio, Yawal, Feal T85, Cortizio 3500, Bauxal	Rohové ložisko spodní a horní Multi Power	100	<b>370082<sup>1</sup></b>	

<sup>1</sup> Použijte rohové ložisko MULTI POWER dřevo FT24

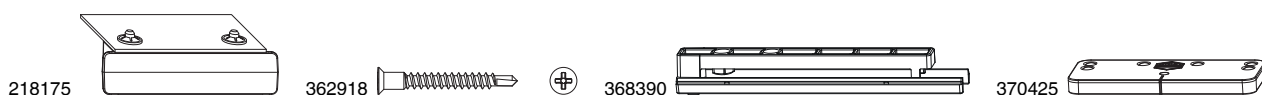

9.8.8.3 Podložky MULTI POWER pro prahy						
Šedá RAL 9022		GKG Grundmeier	pro prahy	20	<b>369939</b>	
		Roto Gluske BKV Eifel TB	pro prahy	20	<b>369944</b>	
		Trocal Alu und GFK	pro prahy	20	<b>369945</b>	
	pravé	VEKA	pro prahy	20	<b>369973</b>	
	levé	VEKA	pro prahy	20	<b>369974</b>	



9.8.9 Příslušenství MULTI POWER		Ø	L			
Šedé F1	montážní krytka Multi Power pravé/levé			5	<b>218175</b>	
Stříbrné	spec.vrt.šrouby Multi Power Phillips	4,5	32	1.000	<b>364563<sup>1</sup></b>	
	spec.vrt.šrouby Multi Power TX 20	4,5	38	500	<b>367828</b>	<b>105152*</b>
	hmoždinky Multi Power Holz		19	50	<b>36668</b>	
Černé	nástrčné díly křídlové díly spod. ložiska Multi Power pro 18L		117	20	<b>368390</b>	
	Vyrovnávací destička pro úzké profily Multi Power Dřevo			100	<b>370425</b>	

<sup>1</sup> Do hmotnosti křídla 100 kg!

## 9.9 Krytky

### 9.9.1 Krytky spodního ložiska



41742

9.9.1.1 Krytky pro spod.ložisko AS/DT/PVC krátké			No	No Tricoat
RAL 9016 bílé	probarvené	100	41742 <sup>1</sup>	
RAL 9022 stříbrné	probarvené	100	43566	
Stříbrné	lakované	100	360232	
Champagne	lakované	100	42049	
Titan	lakované	100	42048	
světle bronzové	probarvené	100	41762	
RAL 9001 krémově bílé	probarvené	100	42207	
hnědé F5	probarvené	100	42195	
Chrom-Look		100	44241	
Gold-Look		100	41763	
Schwarz	probarvené	100	42196	

<sup>1</sup> K dispozici také jako velké balení po 500 ks., obj. č. 42286.



41743

9.9.1.2 Krytky pro spod.ložisko DT130/PVC dlouhé			No	No Tricoat
RAL 9016 bílé	probarvené	100	41743 <sup>1</sup>	
RAL 9022 stříbrné	probarvené	100	43567	
Stříbrné	lakované	100	360231	
Champagne	lakované	100	42058	
Titan	lakované	100	42057	
světle bronzové	probarvené	100	41752	
RAL 9001 krémově bílé	probarvené	100	42215	
hnědé F5	probarvené	100	42208	
Chrom-Look		100	44242	
Gold-Look		100	41760	
Schwarz	probarvené	100	42209	

<sup>1</sup> K dispozici také jako velké balení po 500 ks., obj. č. 42287.



43622

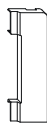

9.9.1.5 Krytky pro spodní ložisko AS dlouhé				<b>No</b>	<b>No</b> Tricoat
RAL 9016 bílé	pravé	probarvené	100	<b>43622</b>	
	levé	probarvené	100	<b>43623</b>	
RAL 9022 stříbrné	pravé	probarvené	100	<b>43743</b>	
	levé	probarvené	100	<b>43744</b>	
Stříbrné	pravé	lakované	100	<b>363353</b>	
	levé	lakované	100	<b>363354</b>	
Champagne	pravé	lakované	100	<b>43733</b>	
	levé	lakované	100	<b>43734</b>	
Titan	pravé	lakované	100	<b>43731</b>	
	levé	lakované	100	<b>43732</b>	
světle bronzové	pravé	probarvené	100	<b>43727</b>	
	levé	probarvené	100	<b>43728</b>	
RAL 9001 krémově bílé	pravé	probarvené	100	<b>43739</b>	
	levé	probarvené	100	<b>43740</b>	
hnědé F5	pravé	probarvené	100	<b>43735</b>	
	levé	probarvené	100	<b>43736</b>	
Chrom-Look	pravé		100	<b>364087</b>	
	levé		100	<b>364088</b>	
Gold-Look	pravé		100	<b>43729</b>	
	levé		100	<b>43730</b>	



362609

9.9.1.6 Krytky spod. ložiska AS pro falc. kř. díl spod. ložiska AS/PVC					<b>No</b>	<b>No</b> Tricoat
RAL 9016 bílé	pravé	probarvené		100	<b>362609</b>	
	levé	probarvené		100	<b>362610</b>	
RAL 9022 stříbrné	pravé	probarvené		100	<b>363998</b>	
	levé	probarvené		100	<b>363999</b>	
Stříbrné	pravé	lakované		100	<b>364004</b>	
	levé	lakované		100	<b>364005</b>	
Champagne	pravé	lakované		100	<b>364096</b>	
	levé	lakované		100	<b>364097</b>	
Titan	pravé	lakované		100	<b>363996</b>	
	levé	lakované		100	<b>363997</b>	
světle bronzové	pravé	probarvené		100	<b>364094</b>	
	levé	probarvené		100	<b>364095</b>	
RAL 9001 krémově bílé	pravé	probarvené		100	<b>364000</b>	
	levé	probarvené		100	<b>364001</b>	
hnědé F5	pravé	probarvené		100	<b>364018</b>	
	levé	probarvené		100	<b>364019</b>	
Chrom-Look	pravé			100	<b>364098</b>	
	levé			100	<b>364099</b>	
Gold-Look	pravé			100	<b>364016</b>	
	levé			100	<b>364017</b>	



364498



365224

<b>H</b>	9.9.1.7 Krytky DŘEVO MULTI POWER					<b>No</b>	<b>No</b> Tricoat
RAL 9022 stříbrné	pravé	DŘEVO FT24	probarvené	20	<b>364498</b>		
	levé	DŘEVO FT24	probarvené	20	<b>364499</b>		
	pravé	DŘEVO FT30	probarvené	20	<b>365224</b>		
	levé	DŘEVO FT30	probarvené	20	<b>365225</b>		



364500

<b>K</b>	9.9.1.8 Krytky PVC MULTI POWER					<b>No</b>	<b>No</b> Tricoat
RAL 9022 stříbrné	pravé	PVC FT30	probarvené	20	<b>364500</b>		
	levé	PVC FT30	probarvené	20	<b>364501</b>		

## 9.9.2 Krytky pro křídlový díl spodního ložiska



42087

<b>K 9.9.2.1 Krytky pro křídlový díl spod.ložiska PVC</b>			<b>No</b>	<b>No</b> Tricoat
RAL 9016 bílé	probarvené	100	<b>42087<sup>1</sup></b>	
RAL 9022 stříbrné	probarvené	100	<b>43940</b>	
Stříbrné	lakované	100	<b>360233</b>	
Champagne	lakované	100	<b>42096</b>	
Titan	lakované	100	<b>42095</b>	
světle bronzové	probarvené	100	<b>42093</b>	
RAL 9001 krémově bílé	probarvené	100	<b>42188</b>	
hnědé F5	probarvené	100	<b>42186</b>	
Chrom-Look		100	<b>44245</b>	
Gold-Look		100	<b>42094</b>	

<sup>1</sup> K dispozici také jako velké balení po 500 ks., obj. č. 42288.

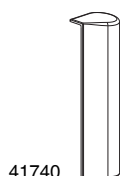

41740

<b>9.9.2.2 Krytky pro falc.křídlový díl spod.ložiska AS/PVC a DT bez UV</b>				<b>No</b>	<b>No</b> Tricoat
RAL 9016 bílé	pravé	probarvené	100	<b>41740</b>	
	levé	probarvené	100	<b>41741</b>	
RAL 9022 stříbrné	pravé	probarvené	100	<b>43564</b>	
	levé	probarvené	100	<b>43565</b>	
Stříbrné	pravé	lakované	100	<b>363116</b>	
	levé	lakované	100	<b>363117</b>	
Champagne	pravé	lakované	100	<b>42064</b>	
	levé	lakované	100	<b>42061</b>	
Titan	pravé	lakované	100	<b>42063</b>	
	levé	lakované	100	<b>42060</b>	
světle bronzové	pravé	probarvené	100	<b>41764</b>	
	levé	probarvené	100	<b>41770</b>	
RAL 9001 krémově bílé	pravé	probarvené	100	<b>43553</b>	
	levé	probarvené	100	<b>43554</b>	
hnědé F5	pravé	probarvené	100	<b>42599</b>	
	levé	probarvené	100	<b>42598</b>	
Chrom-Look	pravé		100	<b>44239</b>	
	levé		100	<b>44240</b>	
Gold-Look	pravé		100	<b>41769</b>	
	levé		100	<b>41771</b>	
Schwarz	pravé	probarvené	100	<b>43518</b>	
	levé	probarvené	100	<b>43519</b>	



363403



**K 9.9.2.3 Krytky falc. křídla. dílu spod.ložiska s příložkou bez UV**



**No**

**No**  
Tricoat

bílé RAL 9016	pravé	probarvené	100	<b>362333</b>	
	levé	probarvené	100	<b>362334</b>	
RAL 9022 stříbrné	pravé	probarvené	100	<b>363508</b>	
	levé	probarvené	100	<b>363509</b>	
Silber	pravé	lakované	100	<b>363403</b>	
	levé	lakované	100	<b>363404</b>	
Titan	pravé	lakované	100	<b>363137</b>	
	levé	lakované	100	<b>363138</b>	
světle bronzové	pravé	probarvené	100	<b>364100</b>	
	levé	probarvené	100	<b>364101</b>	
RAL 9001 krémově bílé	pravé	probarvené	100	<b>363510</b>	
	levé	probarvené	100	<b>363511</b>	
hnědé F5	pravé	probarvené	100	<b>364029</b>	
	levé	probarvené	100	<b>364030</b>	
Chrom-Look	pravé		100	<b>364104</b>	
	levé		100	<b>364105</b>	
Gold-Look	pravé		100	<b>364027</b>	
	levé		100	<b>364028</b>	

43587

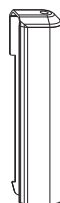

**9.9.2.4 Krytky falc. křídla. dílu spod.ložiska s UV**



**No**

**No**  
Tricoat

bílé RAL 9016	pravé	probarvené	100	<b>43587</b>	
	levé	probarvené	100	<b>43588</b>	
RAL 9022 stříbrné	pravé	probarvené	100	<b>43597</b>	
	levé	probarvené	100	<b>43608</b>	
Silber	pravé	lakované	100	<b>360953</b>	
	levé	lakované	100	<b>360954</b>	
Champagne	pravé	lakované	100	<b>43593</b>	
	levé	lakované	100	<b>43604</b>	
Titan	pravé	lakované	100	<b>43592</b>	
	levé	lakované	100	<b>43603</b>	
světle bronzové	pravé	probarvené	100	<b>43590</b>	
	levé	probarvené	100	<b>43601</b>	
RAL 9001 krémově bílé	pravé	probarvené	100	<b>43598</b>	
	levé	probarvené	100	<b>43609</b>	
hnědé F5	pravé	probarvené	100	<b>43595</b>	
	levé	probarvené	100	<b>43606</b>	
Chrom-Look	pravé		100	<b>44246</b>	
	levé		100	<b>44247</b>	
Gold-Look	pravé		100	<b>43591</b>	
	levé		100	<b>43602</b>	



43651

<b>K 9.9.2.5 Krytky proti nečistotám pro křídlový díl spod.ložiska PVC</b>			<b>N<sup>o</sup></b>	<b>N<sup>o</sup></b> Tricoat
bílé RAL 9016	probarvené	100	<b>40341</b>	
RAL 9022 stříbrné	probarvené	100	<b>43651</b>	
Titan	probarvené	100	<b>209669</b>	
RAL 9007 šedohliníkové	probarvené	100	<b>224132</b>	
RAL 8019 šedohnědé	probarvené	100	<b>203287</b>	



43626

<b>9.9.2.6 Krytky proti nečistotám pro křídlový díl spod.ložiska AS/DT/TO s UV</b>			<b>N<sup>o</sup></b>	<b>N<sup>o</sup></b> Tricoat
bílé RAL 9016	probarvené	100	<b>42166</b>	
RAL 9022 stříbrné	probarvené	100	<b>43626</b>	
Titan	probarvené	100	<b>358989</b>	
RAL 8019 šedohnědé	probarvené	100	<b>360230</b>	
Perlgold RAL 1036	probarvené	100	<b>40342</b>	



42185

<b>9.9.2.7 Krytky proti nečistotám pro falc.křídlový díl spod.ložiska AS/PVC a DT bez UV</b>			<b>N<sup>o</sup></b>	<b>N<sup>o</sup></b> Tricoat
bílé RAL 9016	probarvené	100	<b>42185</b>	
RAL 9022 stříbrné	probarvené	100	<b>43701</b>	
RAL 8022 černo hnědé	probarvené	100	<b>368556</b>	

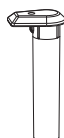

364726

<b>9.9.2.8 Krytky proti nečistotám pro křídlový díl spod.ložiska MULTI MAMMUT</b>			<b>N<sup>o</sup></b>	<b>N<sup>o</sup></b> Tricoat
bílé RAL 9016	probarvené	100	<b>364726</b>	
RAL 9022 stříbrné	probarvené	100	<b>363148</b>	
Titan	probarvené	100	<b>367573</b>	

## 9.10 Příslušenství spodních ložisek



40485



9.10.1 Podložky pro křídlové díly spodních ložisek				<b>N<sup>o</sup></b>	<b>N<sup>o</sup></b> Tricoat
černé	podložky	pro kř.díl spod.ložiska AS/DTuni	100	<b>40485</b>	
	podložky s 1mm odstupem	pro kř.díl spod.ložiska AS/DTuni	100	<b>40486</b>	
	podložky pro kř.díl spod.ložiska	pro kř.díl spod.ložiska AS/DTuni	100	<b>44234</b>	

36668



369535



<b>H</b>	9.10.2 Podpurná a nosná hmoždinka			<b>L</b>		<b>N<sup>o</sup></b>	<b>N<sup>o</sup></b> Tricoat
stříbrné	hmoždinka pro spodní ložiska Multi Power Dřevo		19	50	<b>36668</b>	<b>355715*</b>	
	hmoždinka pro rohové ložisko DT160 4L / 12L		8	20	<b>369535</b>		





## 10 Štulpové závory

---

### 10.1 Hranové zástrče

---

- 10.1.1 Hranové zástrče spodní
- 10.1.2 Hranové zástrče spodní pod prahy
- 10.1.3 Hranové zástrče horní
- 10.1.4 Hranové zástrče spodní/horní
- 10.1.5 Příslušenství hranových zástrčí

### 10.2 Štulpové převodovky

---

- 10.2.1 Štulpové převodovky pro kovací drážku
- 10.2.2 Štulpové převodovky pro Euronut
- 10.2.3 Štulpové převodovky pro meziprofil (bez uzávěrů)

### 10.3 Štulpové zástrče vodorovné

---

### 10.4 Uzávěrové lišty

---

### 10.5 Prodloužení štulpu pro uzávěrovou lištu

---

### 10.6 Příslušenství pro 2-kř. okna

---

- 10.6.1 Mezipřevodovky
- 10.6.2 Příslušenství pro mezipřevodovky
- 10.6.3 Krytky spáry MM
- 10.6.4 Krytky spáry MM-KS
- 10.6.5 Krytky spáry pro Euronut
- 10.6.6 Alu - kanál pro štulpovou převodovku
- 10.6.7 Fixace nůžek pro druhé křídlo EH

### 10.7 Příslušenství pro štulpové převodovky

---

- 10.7.1 Západky pro štulpovou převodovku
- 10.7.2 Schnapperrollen
- 10.7.3 Uzávěry i.S. pro štulpové převodovky MM-KS
- 10.7.4 Uzávěry stfelky pro B-TV

## 10 Štulpové závory

### 10.1 Hranové zástrče



10.1.1 Hranové zástrče spodní		L		N <sup>o</sup>	N <sup>o</sup> Tricoat
stříbrné	hranové zástrče spodní pravé MMKS pro kovací drážku	170	20	214445	
	hranové zástrče spodní levé MMKS pro kovací drážku	170	20	214446	
	MT/MM 4L R8	170	20	55409	205068
	MT/MM Euronut	170	20	52504	201770
	MT/MM Eurofalz FT18 9V	170	20	55167	202383
	MM-KS Eurofalz FT24 13V	170	20	218177	219170*
	konzole hladká krátké s kyvným uzávěrem a náběhem GM 300 MM	288	20	215781	
	konzole hladká krátké s kyvným uzávěrem a náběhem GM 400 MM	288	20	215780	
	krátké s kyvným uzávěrem a náběhem GM 300 MM-KS	288	20	215304	
	krátké s kyvným uzávěrem a náběhem GM 400 MM-KS	288	20	215303	
	s i.S. uzávěrem a náběhem zvedače GM 300 MM	288	20	208955	
s i.S. uzávěrem a náběhem zvedače GM 400 MM	288	20	208954	215148	

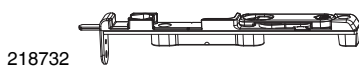

10.1.2 Hranové zástrče spodní pod prahy		L		N <sup>o</sup>	N <sup>o</sup> Tricoat
stříbrné	pravé MM/MM-KS pro kovací drážku a 18 mm zástrčku	170	20	218732	
	levé MM/MM-KS pro kovací drážku a 18 mm zástrčku	170	20	218733	

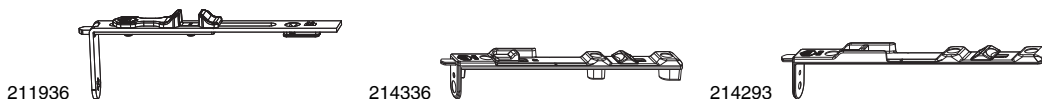

10.1.3 Hranové zástrče horní		L		N <sup>o</sup>	N <sup>o</sup> Tricoat
stříbrné	s řízeným ovládním MM	138	20	211936	
	pravé MM/MM-KS pro kovací drážku	162	20	214336	217511
	levé MM/MM-KS pro kovací drážku	162	20	214337	217510
	MM/MM-KS Euronut	162	20	213922	218759
	MM/MM-KS Eurofalz FT18 9V	162	20	214293	217442
	MM/MM-KS Eurofalz FT24 13V	162	20	218176	219169
	MM/MM-KS 4L R8	170	20	214506	
	s i.S. uzávěrem a pákou MM	450	20	209073	

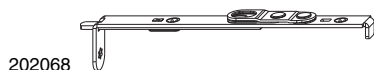

10.1.4 Hranové zástrče spodní/horní		L		No	No Tricoat
stříbrné	ploché MT/MM pro kovací drážku	180	20	202068	212712
	MT/MM pro kovací drážku	286	20	208956	
	pro uzávěry a páku MM pro kovací drážku	450	20	215240 <sup>1</sup>	

<sup>1</sup> Pasuje uzávěr Art. Nr. 94221.

### 10.1.5 Příslušenství hranových zástrčí





10.1.5.1 Podložky pro kovací drážku s hranovou zástrčí pro Euronut		L		No	No Tricoat
přírodní		169	100	41263	

## 10.2 Štulpové převodovky



### 10.2.1 Štulpové převodovky pro kovací drážku

221902 

10.2.1.1 Štulpové převodovky pro kovací drážku fix					N <sup>o</sup>	N <sup>o</sup> Tricoat	
stříbrné	pro 1 i.S.	660	190	431 - 660	10	<b>202873<sup>1</sup></b>	<b>207630<sup>1*</sup></b>
		840	300	661 - 840	10	<b>221901</b>	<b>207631*</b>
		1090	400	841 - 1.090	10	<b>221902</b>	<b>207632*</b>
	pro 2 i.S.	1340	500	1.091 - 1.340	10	<b>221903</b>	<b>207633*</b>
		1590	600	1.341 - 1.590	10	<b>221906</b>	<b>207634*</b>
		1700	700	1.591 - 1.700	10	<b>207242</b>	<b>207635*</b>
	pro 3 i.S.	1950	1.050	1.701 - 1.950	10	<b>221907</b>	<b>207636*</b>
		2200	1.050	1.951 - 2.200	10	<b>221908</b>	<b>207637*</b>
	pro 4 i.S.	2450	1.050	2.201 - 2.450	10	<b>221909</b>	<b>207638*</b>



<sup>1</sup> Použitelné jen ve spojení s O-převodovkou 660 (201731).

209508 

10.2.1.3 Štulpové převodovky pro KS pro kovací drážku fix					N <sup>o</sup>	N <sup>o</sup> Tricoat	
stříbrné	pro 1 VZ	840	300	661 - 840	10	<b>209507<sup>1</sup></b>	<b>222681<sup>1</sup></b>
		1090	400	841 - 1.090	10	<b>209508</b>	<b>222682*</b>
		1340	500	1.091 - 1.340	10	<b>209510</b>	<b>222684*</b>
	pro 2 VZ	1590	600	1.341 - 1.590	10	<b>209512</b>	<b>222686</b>
		1700	700	1.591 - 1.700	10	<b>209514</b>	<b>222688</b>
		1950	1.050	1.701 - 1.950	10	<b>209517</b>	<b>222691</b>
	pro 3 VZ	2200	1.050	1.951 - 2.200	10	<b>209518</b>	<b>222692*</b>
		2450	1.050	2.201 - 2.450	10	<b>209519</b>	<b>222693*</b>

<sup>1</sup> Použitelné jen ve spojení s O-převodovkou 840 (209590 s KS).

221904 

10.2.1.6 Štulpové převodovky EH pro kovací drážku fix					N <sup>o</sup>	N <sup>o</sup> Tricoat	
stříbrné	pro 2 i.S.	840	300	661 - 840	10	<b>206582<sup>1,2</sup></b>	<b>207639<sup>1,2</sup></b>
		1090	400	841 - 1.090	10	<b>221904<sup>2</sup></b>	<b>207640<sup>2</sup></b>
		1340	500	1.091 - 1.340	10	<b>221905<sup>2</sup></b>	<b>207641<sup>2</sup></b>
	pro 3 i.S.	1590	600	1.341 - 1.590	10	<b>205643<sup>2</sup></b>	<b>207642<sup>2</sup></b>
		1700	700	1.591 - 1.700	10	<b>207308<sup>2,3</sup></b>	<b>207643<sup>2,3</sup></b>



<sup>1</sup> Použitelné jen ve spojení s O-převodovkou EH 840 (206614).

<sup>2</sup> Použit u oken podle EN-NORM.

<sup>3</sup> Od FFH 1700 používat štulpovou převodovku pro kovací drážku fix se spodním ukončením EH.



227937 

202471 

10.2.1.9 Štulpové převodovky pro kovací drážku variabilní i.S.						No	No Tricoat
stříbrné	pro 1 i.S.	800	695 - 800	10	<b>227937<sup>1</sup></b>		
		1250	801 - 1.250	10	<b>202471<sup>1</sup></b>	<b>207644<sup>1*</sup></b>	
	pro 2 i.S.	1750	1.251 - 1.750	10	<b>202472</b>	<b>207645*</b>	
	pro 3 i.S.	2250	1.751 - 2.250	10	<b>202473</b>	<b>207646*</b>	

<sup>1</sup> Použitelné jen ve spojení s rohovým převodem 202475.



211791 

10.2.1.10 Štulpové převodovky pro kovací drážku variabilní VZ						No	No Tricoat
stříbrné	pro 1 VZ	1250	840 - 1.250	10	<b>211791<sup>1</sup></b>		
	pro 2 VZ	1750	1.251 - 1.750	10	<b>209670</b>		
	pro 3 VZ	2250	1.751 - 2.250	10	<b>209671</b>		



<sup>1</sup> Použitelné jen ve spojení s ukončením 209648. S polohou kliky uprostřed se oblast použití (AWB) mění na 930 - 1250 mm.

10.2.1.12 Příslušenství štulpových převodovek pro kovací drážku







10.2.1.12.1 Prodloužení štulpu pro štulpové převodovky					 Tricoat
stříbrné	pro 1 i.S.	235	20	203810	207559*
		470	20	208333	208369*
	pro 1 VZ	235	20	214712	223048

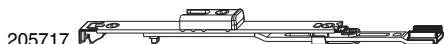

10.2.1.12.2 Ukončení štulpové převodovky MM-KS s výsuv.trnem					 Tricoat
stříbrné	horní		20	211745 <sup>1</sup>	222748 <sup>1*</sup>
	spodní		20	209637	222709
		s pákou	20	209648	222711

<sup>1</sup> Uzávěr přibalen.



10.2.1.12.3 Ukončení spodní štulpové převodovky variabilní						 Tricoat
stříbrné		s uzávěrem spodním	1.340 - 2.450	20	205717 <sup>1</sup>	207557 <sup>1</sup>

<sup>1</sup> Použít u oken podle EN-NORM.



10.2.1.12.4 Krytky závěru pro štulpovou převodovku MM					 Tricoat
stříbrné			100	44660	



10.2.1.12.5 Uzavírací zarážky pro štulpovou převodovku MM					 Tricoat
stříbrné			100	97550 <sup>1</sup>	

<sup>1</sup> Samořezné šrouby 44162 přiojednat!





10.2.1.12.6 Závitové šrouby M5x12 pro uzavírací zarážku MM			L			 Tricoat
stříbrné			12	100	44162	

## 10.2.2 Štulpové převodovky pro Euronut



226635



H 10.2.2.1 Štulpové převodovky pro Euronut fix					No	No Tricoat	
stříbrné	pro 1 i.S.	660	190	431 - 660	10	203482 <sup>1,2</sup>	207650 <sup>1,2</sup>
		840	300	661 - 840	10	226629 <sup>1</sup>	
		1090	400	841 - 1.090	10	226635 <sup>1</sup>	
		1340	500	1.091 - 1.340	10	226636 <sup>1</sup>	
pro 2 i.S.	1590	600	1.341 - 1.590	10	226637 <sup>1</sup>		
	1700	700	1.591 - 1.700	10	226638 <sup>1</sup>		
pro 3 i.S.	1950	1.050	1.701 - 1.950	10	226639 <sup>1</sup>		
	2200	1.050	1.951 - 2.200	10	226640 <sup>1</sup>	226754 <sup>1</sup>	
pro 4 i.S.	2450	1.050	2.201 - 2.450	10	226641 <sup>1</sup>	226755 <sup>1</sup>	

<sup>1</sup> Připevňovací sponu č. 94035 nebo držák štulpu č. 94036 přibjednat. Typ a počet upevňovacích prvků závisí na možnostech štulpové převodovky po zkrácení na délku.

<sup>2</sup> Použitelné je s O-převodovkou DM 15!



226646



H 10.2.2.3 Štulpové převodovky für Kippschwinge pro Euronut fix					No	No Tricoat	
stříbrné	pro 1 VZ	840	300	661 - 840	10	209556 <sup>1,2</sup>	222694 <sup>1,2</sup>
		1090	400	841 - 1.090	10	226646 <sup>1</sup>	226757 <sup>1</sup>
		1340	500	1.091 - 1.340	10	226647 <sup>1</sup>	226758 <sup>1</sup>
		1590	600	1.341 - 1.590	10	226648 <sup>1</sup>	226759 <sup>1</sup>
pro 2 VZ	1700	700	1.591 - 1.700	10	226649 <sup>1</sup>	226760 <sup>1</sup>	
	1950	1.050	1.701 - 1.950	10	226650 <sup>1</sup>	226761 <sup>1</sup>	
pro 3 VZ	2200	1.050	1.951 - 2.200	10	226651 <sup>1</sup>	226762 <sup>1</sup>	
	2450	1.050	2.201 - 2.450	10	226652 <sup>1</sup>	226763 <sup>1</sup>	

<sup>1</sup> Připevňovací sponu č. 94035 nebo držák štulpu č. 94036 přibjednat. Typ a počet upevňovacích prvků závisí na možnostech štulpové převodovky po zkrácení na délku.

<sup>2</sup> Použitelné je s O-převodovkou DM 15!



226658

H 10.2.2.6 Štulpové převodovky pro Euronut variabilní				No	No Tricoat	
stříbrné	pro 1 i.S.	1250	801 - 1.250	10	226658 <sup>1,2</sup>	226769 <sup>1,2</sup>
	pro 1 VZ	1250	840 - 1.250	10	226659 <sup>2,3</sup>	
	pro 2 i.S.	1750	1.251 - 1.750	10	226660 <sup>2</sup>	226771 <sup>2</sup>
	pro 3 i.S.	2250	1.751 - 2.250	10	226661 <sup>2</sup>	226772 <sup>2</sup>

<sup>1</sup> Ukončení 203771 nutné (délka 200 mm).

<sup>2</sup> Připevňovací sponu + držák štulpu přibjednat.

<sup>3</sup> Ukončení 209647 nutné (délka 269 mm) se sklopným uzávěrem.

### 10.2.2.7 Příslušenství štulpových převodovek pro Euronut

218626  203480  205921 

H 10.2.2.7.1 Prodloužení štulpu pro štulpové převodovky MM pro Euronut			N <sup>o</sup>	N <sup>o</sup> Tricoat
stříbrné	140 bez uzávěru	20	<b>218626</b>	<b>225238</b>
	235 s uzávěrem	20	<b>203480</b>	<b>207561</b>
	470 s uzávěrem	20	<b>218627</b>	<b>225239</b>
	Spojovací plíšky MM Euronut	50	<b>205921</b>	<b>208317</b>

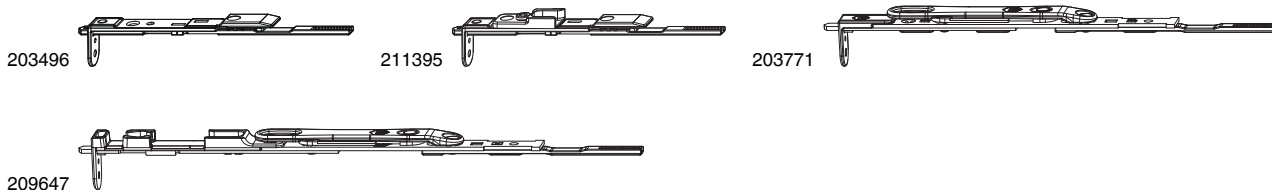



H 10.2.2.8 Ukončení štulpové převodovky pro Euronut			N <sup>o</sup>	N <sup>o</sup> Tricoat	
stříbrné	ukončení štulpové převodovky MM Euronut	horní s výsuv.trnem	20	<b>203496</b>	<b>207562</b>
		horní s uzávěrem s výsuv.trnem	20	<b>211395</b>	<b>217454</b>
		spodní s pákou	20	<b>203771<sup>1,2</sup></b>	<b>207563<sup>1,2</sup></b>
	ukončení štulpové převodovky MMKS Euronut	spodní s výsuv.trnem	20	<b>209775</b>	<b>222714</b>
		spodní s pákou	20	<b>209647<sup>1,3</sup></b>	<b>222710<sup>1,3</sup></b>

<sup>1</sup> Přiobjednat spojovací plíšky 205921!

<sup>2</sup> Použit pro štulpovou převodovku. 226658!

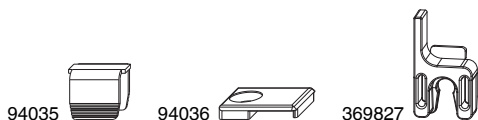

<sup>3</sup> Použit pro štulpovou převodovku 226659!



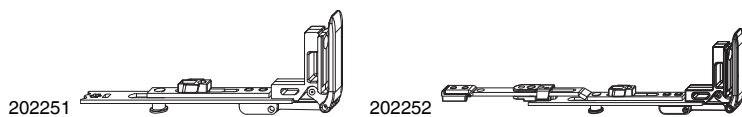

H 10.2.2.9 Příslušenství štulpových převodovek EURONUT			N <sup>o</sup>	N <sup>o</sup> Tricoat
stříbrné	upevňovací díly	100	<b>94035</b>	<b>353299</b>
	držáky štulpu	50	<b>94036</b>	<b>355818</b>
stříbrné RAL 9022	Opravný díl náběhu pro štulpové převodovky levý	50	<b>369827</b>	
	Opravný díl náběhu pro štulpové převodovky pravý	50	<b>369828</b>	





<b>10.3 Štulpové zástrče vodorovné</b>				<b>No</b>	<b>No</b> Tricoat
stříbrné	štulpové ukončení MM	230 - 800	20	<b>202251</b>	<b>207662</b>
	štulpové ukončení prodlužitelné MM	240 - 1.650	20	<b>202252</b>	<b>207663</b>



<b>10.4 Uzávěrové lišty</b>		<b>L</b>				<b>No</b>	<b>No</b> Tricoat	
stříbrné	pro 1 i.S.	840	809,5	300	661 - 840	10	<b>202126</b>	<b>207665</b>
		1340	1.296,5	500	841 - 1.340	10	<b>202128</b>	<b>207666</b>
	pro 2 i.S.	1590	1.559,5	600	1.341 - 1.590	10	<b>202131</b>	<b>207667</b>
	pro 3 i.S.	2200	2.169,5	1.050	1.701 - 2.200	10	<b>202133</b>	<b>207668</b>

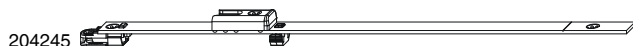

<b>10.5 Prodloužení štulpu pro uzavěrové lišty MM s uzávěrem</b>		<b>L</b>		<b>No</b>	<b>No</b> Tricoat
stříbrné		349,5	20	<b>204245</b>	

## 10.6 Příslušenství pro 2-kř. okna

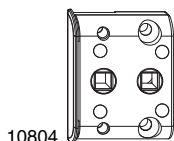

10804

### H 10.6.1 Mezipřevodovky s čtyřhranem



**No**

**No**  
Tricoat

stříbrné							
	4L/15Ú/9V	-3,5	20			<b>10945<sup>1</sup></b>	<b>101356<sup>1</sup></b>
	12L/18Ú/9V	-6	20			<b>10804<sup>1</sup></b>	<b>101357<sup>1</sup></b>
	12L/18Ú/13V	-6	20			<b>102233<sup>1</sup></b>	
	12L/20Ú/9V	-6	20			<b>10920<sup>1</sup></b>	<b>101358<sup>1</sup></b>
	12L/20Ú/13V	-6	20			<b>102234<sup>1</sup></b>	

<sup>1</sup> Pro plastová okna po konzultaci.

### 10.6.2 Příslušenství pro mezipřevodovky



44274

### H 10.6.2.1 Mezikus pro mezipřevodovky

**L**



**No**

**No**  
Tricoat

stříbrné	9V						
		5 mm (pro SV150-180, SV415a-418-155)	56	5	100	<b>44274<sup>1</sup></b>	
		6 mm (pro SV33, SV103)	56	6	100	<b>44250<sup>2</sup></b>	
		7 mm (pro SV33, SV103)	56	7	100	<b>44300<sup>3</sup></b>	
		bez nalehávkového těsnění 1mm odstup	56	1,5	100	<b>360221</b>	
	13V	10 mm (pro SV33, SV103)	56	11	100	<b>356970</b>	
		10 mm (pro SV150-180, SV415a-418-155)	56	11	100	<b>43509</b>	
		bez nalehávkového těsnění	56	6	100	<b>360220</b>	

<sup>1</sup> pro nalehávkové těsnění 9 mm předsazení, bez nalehávkového těsnění 13 mm předsazení.

<sup>2</sup> pro nalehávkové těsnění SV33, SV103.

<sup>3</sup> pro nalehávkové těsnění o 1 mm silnější.



32365

### H 10.6.2.2 Čtyřhran pro mezipřevodovky



**No**

**No**  
Tricoat

7x20 mm	100	<b>32365</b>	
7x25 mm	100	<b>32412<sup>1</sup></b>	
7x30 mm	20	<b>93228<sup>2</sup></b>	

<sup>1</sup> pro nalehávkové těsnění 9 mm předsazení, bez nalehávkového těsnění 13 mm předsazení.

<sup>2</sup> pro nalehávkové těsnění 13 mm předsazení.



94219

### 10.6.2.3 navrtávací pouzdra pro zástrč 8 x 4 mm



**No**

**No**  
Tricoat

stříbrné	100	<b>94219</b>	
----------	-----	--------------	--

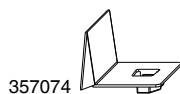

357074

10.6.3 Krytky spáry pro MM				No	No Tricoat
stříbrné	levé horní	9V	100	357078	
		11V	100	357074	
		13V	100	357075	
	levé spodní	9V	100	357091	
		11V	100	357092	
		13V	100	357093	
	pravé horní	9V	100	357088	
		11V	100	357089	
		13V	100	357090	
	pravé spodní	9V	100	357079	
		11V	100	357076	
		13V	100	357077	



360950

10.6.4 Krytky spáry pro MM s KS				No	No Tricoat
stříbrné	horní levé/spodní pravé	9V	100	360950	
		11V	100	365193	
		13V	100	365195	
	horní pravé/spodní levé	9V	100	360951	
		11V	100	365194	
		13V	100	365196	

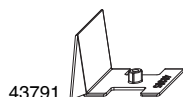

43791

10.6.5 Krytky spáry pro Euronut křídlové díly				No	No Tricoat
stříbrné RAL 9022			100	43791	



37535

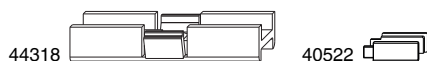

44318

40522

H 10.6.6 Alu - kanál pro štulpovou převodovku		L		No	No Tricoat
Blank	Alu-kanály pro štulpové převodovky	1.000	10	37535	
		1.250	10	37536	
		1.500	10	37537	
		1.800	10	37554	
		2.350	10	37538	
		2.600	10	357399	
		6.000	10	37571	
stříbrné	Podložka pod zubovou spojku		100	44318	
bílé	koncovky pro ALUprofil (F)		100	40522	

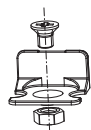

105316

<b>10.6.7 Fixace nůžek pro druhé křídlo EH</b>				<b>No</b>	<b>No</b> Tricoat
stříbrné			50	<b>105316</b>	

## 10.7 Příslušenství štulpových převodovek

213460 

<b>H</b> <b>10.7.1 Západy pro štulpovou převodovku</b>		<b>No</b>	<b>No</b> Tricoat
stříbrné	50	<b>213460<sup>1,2</sup></b>	

<sup>1</sup> Doobjednat rolničku ocelovou č. 362446 nebo z PVC č. 362060!

<sup>2</sup> Pro kovací drážku použít podložku č. 362059!



362446

<b>10.7.2 Rolničky pro západku</b>				<b>No</b>	<b>No</b> Tricoat
stříbrné RAL 9022	Rolnička pro západku z PVC		100	<b>362060</b>	
stříbrné	Rolnička pro západku z ocele		100	<b>362446</b>	

365791 

<b>10.7.3 Uzávěr i.S. pro štulpové převodovky MM-KS</b>				<b>No</b>	<b>No</b> Tricoat
stříbrné	pro SFG MM-KS		100	<b>365791</b>	<b>366724</b>

35178



218605



<b>10.7.4 Uzávěry střelky pro B-TV</b>				<b>No</b>	<b>No</b> Tricoat
stříbrné	pro Štulpové převodovky	s 1 otvorem fix	50	<b>35178</b>	<b>355819</b>
		nastavitelný	50	<b>218605</b>	







## 12 Příslušenství MULTI MATIC

---

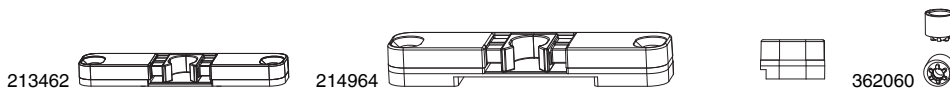
- 12.1 Západky / rolničky pro 2kř. okna \_\_\_\_\_
- 12.2 Západky / rolničky z PVC pro 2kř. okna \_\_\_\_\_
- 12.3 Pojistky otvírání samozavírací \_\_\_\_\_
- 12.4 Pojistky otvírání skryté 4L \_\_\_\_\_
- 12.5 Pojistky otvírání skryté MM 12L \_\_\_\_\_
- 12.6 Multi Vent - omezovače otvírání \_\_\_\_\_
- 12.7 Stavěče větrací polohy \_\_\_\_\_
- 12.8 Stavěče větrací polohy pro 2kř. okna \_\_\_\_\_
- 12.9 Stavěče větrací polohy pro otvíravá okna \_\_\_\_\_
- 12.10 Bezpečnostní přitlačné panty \_\_\_\_\_
- 12.11 Omezovače otvírání \_\_\_\_\_
- 12.12 Omezovače otvírání \_\_\_\_\_
- 12.13 Omezovače otvírání MULTI POWER \_\_\_\_\_
- 12.14 Omezovače otvírání/ Stavěcí brzdy \_\_\_\_\_
- 12.15 Stavěč křídla Komfort \_\_\_\_\_
- 12.16 MULTI SKY kování pro světlíky \_\_\_\_\_
- 12.17 Zajištění proti vypadnutí Safety Pin \_\_\_\_\_
- 12.18 Díly pro e-kování \_\_\_\_\_
- 12.19 Závěsy mřížek \_\_\_\_\_
- 12.20 Spojky mřížek \_\_\_\_\_
- 12.21 Spojky mřížek k zavrtání \_\_\_\_\_
- 12.22 Universal-závěsy \_\_\_\_\_
- 12.23 Universal-spojky \_\_\_\_\_
- 12.24 Kování pro hliníkové opláštění \_\_\_\_\_
- 12.25 Falcové náběhy \_\_\_\_\_
- 12.26 Náběhy pro prahy \_\_\_\_\_
- 12.27 Vruty \_\_\_\_\_
- 12.28 Bezpečnostní podložka \_\_\_\_\_
- 12.29 Zubové spojky MM \_\_\_\_\_
- 12.30 Nástrčná pouzdra pro i-S čepy pro 3kř. okna \_\_\_\_\_
- 12.31 Krycí štulpy \_\_\_\_\_
- 12.32 Lak pro Tricoat \_\_\_\_\_
- 12.33 Příslušenství \_\_\_\_\_



## 12 Příslušenství MULTI-MATIC



12.1 Západy / rolničky pro 2kř. okna				 Tricoat
stříbrné	Západy DŘEVO FT18 9V a FT22 13V	50	<b>213461</b>	
	Západy DŘEVO FT20 9V a FT24 13V	50	<b>213462</b>	<b>217455</b>
	Západy Euronut	50	<b>214804</b>	
	Rolníčky pro západku pro DŘEVO 9V	s deskou	50	<b>215372</b>
	Rolníčky pro západku pro DŘEVO 13V	s deskou	50	<b>215374</b>
	Rolníčky pro západku kovací drážka	s deskou	50	<b>215373</b>
	Rolníčky pro západku ocel		100	<b>362446</b>
	Západy štulpové převodovky		50	<b>213460</b>
	Západy protilehlé kovací drážka		50	<b>214964</b>
	Podložka rolničky pro západku kovací drážka		100	<b>362059<sup>1</sup></b>
RAL 9022 stříbrné	Rolníčky pro západku PVC	100	<b>362060</b>	



<sup>1</sup> Použít při montáži v kovací drážce!



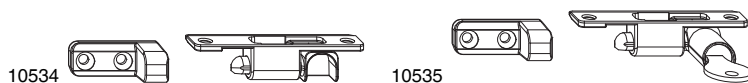

12.2 Západy / rolničky z PVC pro 2kř. okna				 Tricoat
stříbrné	Západy 2-kř. 4L 9V zafrézovatelné	50	<b>220080<sup>1</sup></b>	
	Západy 2-kř. bez kovací drážky	50	<b>57891</b>	
	Západy 2-kř. pro kovací drážku	50	<b>55189</b>	
	Rolníčky pro západku Eurofalz 10x7 mm	100	<b>44174</b>	
	Rolníčky pro západku Euronut 10x7 mm s můstkem	100	<b>44175</b>	
	Rolníčky pro západku Eurofalz 10x9 mm	100	<b>94111</b>	

<sup>1</sup> Délka frézování 120 mm.

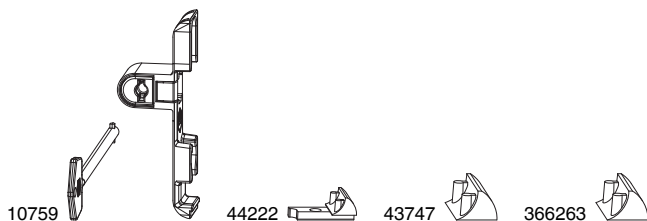

12.3 Pojistky otvírání samozavírací				 Tricoat
stříbrné	pojistky otvírání samozavírací	20	<b>10534</b>	<b>102049</b>
	pojistky otvírání samozavírací uzamykatelné	20	<b>10535</b>	<b>102193</b>
	podložky pro rámový díl pojistky otvírání samozavírací 2 mm	20	<b>366651</b>	
	klíč pro uzamykatelnou pojistku otvírání 2D057	100	<b>40401</b>	
RAL 9016 bílé	pojistky otvírání samozavírací	20	<b>12067</b>	
	pojistky otvírání samozavírací uzamykatelné	20	<b>12069</b>	
RAL 8019 šedohnědé	pojistky otvírání samozavírací	20	<b>12068</b>	
	pojistky otvírání samozavírací uzamykatelné	20	<b>12070</b>	



<b>H 12.4 Pojistky otvírání skryté 4L</b>				<b>No</b>	<b>No</b> Tricoat
stříbrné		pojistky otvírání skryté 4L 9V	20	<b>10759</b> <sup>1,2,3,4</sup>	<b>100036</b> <sup>1,2,3,4</sup>
	pravé	pojistky otvírání skryté 4L 13V	20	<b>103874</b> <sup>2,3,5,6</sup>	
	levé	pojistky otvírání skryté 4L 13V	20	<b>103875</b> <sup>2,3,5,6</sup>	
		Klíč	50	<b>94079</b>	
RAL 9022 stříbrné	pravé	koncovky pro protikus otv.pojistky Euronut 6/8/4	100	<b>44222</b>	
	levé	koncovky pro protikus otv.pojistky Euronut 6/8/4	100	<b>44223</b>	
		koncovky pro protikus otv.pojistky Eurofalz	100	<b>43747</b>	
		koncovky pro protikus otv.pojistky 12L	20	<b>366263</b>	

<sup>1</sup> 9V: 18 mm hloubka frézování.

<sup>2</sup> U 4L délka frézování 90 mm.

<sup>3</sup> Obsah balení: pojistka otvírání a klíč.

<sup>4</sup> Pro DŘEVO 18FT 9V použít koncovky 43747 a pro Euronut 6/8/4 použít koncovky 44222 pravé popř. 44223 levé.

<sup>5</sup> Pro 12L použít koncovky 366263.

<sup>6</sup> 11 + 13V: 22 mm hloubka frézování.

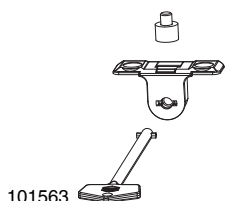

<b>12.5 Pojistky otvírání skryté MM 12L</b>				<b>No</b>	<b>No</b> Tricoat
stříbrné		uzamykatelné 9V	20	<b>101563</b> <sup>1</sup>	
		uzamykatelné 13V	20	<b>101562</b> <sup>1</sup>	<b>103414</b> <sup>1</sup>
		klíč	50	<b>94079</b>	

<sup>1</sup> Obsah balení : pojistka otvírání, čep , vruty, klíč.

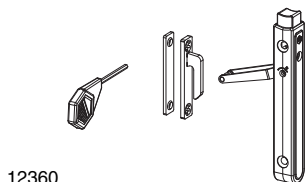

<b>12.6 MULTI VENT - omezovače otvírání</b>				<b>No</b>	<b>No</b> Tricoat
RAL 9016 bílé			20	<b>12360</b>	
RAL 9001 krémově bílé			20	<b>101524</b>	
RAL 8019 šedohnědé			20	<b>12361</b>	
bílé		podložky 5°	100	<b>42509</b>	
		podložky 15°	100	<b>42514</b>	

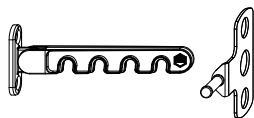

101671

12.7 Stavěče větrací polohy			N <sup>o</sup>	N <sup>o</sup> Tricoat
stříbrné	pravé	50	10890	
	levé	50	10891	
RAL 9016 bílé	pravé	50	10137	
	levé	50	10138	
	levé/pravé pro upevnění kliky HARMONY	50	101671	
	levé/pravé pro upevnění kliky RHAPSODY	50	101672	
RAL 9022 stříbrné	levé/pravé pro upevnění kliky HARMONY	50	101673	
	levé/pravé pro upevnění kliky RHAPSODY	50	101674	
Tiefschwarz RAL 9005	pravé	50	12460	
	levé	50	12461	



10892

12.8 Stavěče větrací polohy pro 2kř. okna			N <sup>o</sup>	N <sup>o</sup> Tricoat
stříbrné	pravé	50	10892	
	levé	50	10893	

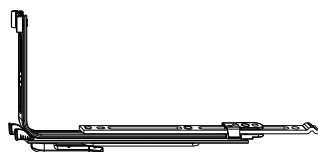

209303

12.9 Stavěče větrací polohy pro otvíravá okna			N <sup>o</sup>	N <sup>o</sup> Tricoat
stříbrné	9V/13V	20	209303	

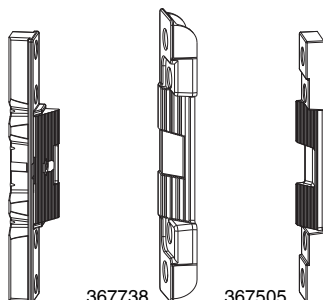

217584

367738

367505

12.10 Bezpečnostní přítlačné panty			N <sup>o</sup>	N <sup>o</sup> Tricoat
stříbrné	bezpečnostní přítlačné panty křídlových díl	20	217584 <sup>1,2,3</sup>	224968 <sup>1,2,3</sup>
	bezpečnostní přítlačné panty rámový díl 4L 9V	20	368014 <sup>4,5</sup>	
	bezpečnostní přítlačné panty rámový díl 4L 13V	20	367738 <sup>5,6</sup>	
	bezpečnostní přítlačné panty rámový díl DŘEVO FT18 9V a FT22 13V	20	367505	367721
	bezpečnostní přítlačné panty rámový díl Euronut	20	367722	367723

<sup>1</sup> Křídlo musí mít v oblasti osazení křídlových částí kovací drážku.

<sup>2</sup> pro PVC a DŘEVO - Alu profily viz profilové listy.

<sup>3</sup> Musí být použita Maco bezpečnostní třída B a D.

<sup>4</sup> 18 mm hloubka frézování.

<sup>5</sup> Délka frézování 120 mm.

<sup>6</sup> 22 mm hloubka frézování.



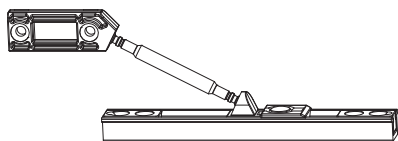

214718

214716

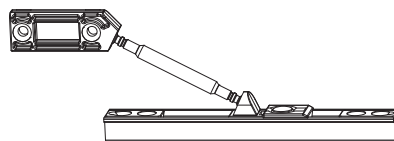

### 12.11 Omezovače otvírání



No

No  
Tricoat

stříbrné	omezovače otvírání skryté DŘEVO	20	214718
	omezovače otvírání skryté PVC	20	214716

101517



101519

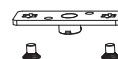

s koncovkou Typ 1

101520



s koncovkou Typ 2

### 12.12 Omezovače otvírání



No

No  
Tricoat

stříbrné	omezovače otvírání DŘEVO Eurofalz	240 - 1.300	80	20	101517 <sup>1,2</sup>	101888 <sup>1,2</sup>
	omezovače otvírání DŘEVO Euronut	240 - 1.300	80	20	101518 <sup>1,2</sup>	
	omezovače otvírání PVC / TV PVC s koncovkou Typ 1	240 - 1.300	80	20	101519 <sup>1,2</sup>	
	omezovače otvírání PVC / TV PVC s koncovkou Typ 2	240 - 1.300	80	20	101520 <sup>1,2</sup>	
	omezovače otvírání TV DŘEVO Eurofalz	240 - 1.300	80	20	206207	
	omezovače otvírání MM pro oblouky	505 - 1.300	80	20	103080	
	podložky pro omezovače otvírání křídlový díl pro kovací drážku			100	40456	
	šrouby pro omezovač otvírání pro oblouky			100	101655	

<sup>1</sup> Ve spojení s vodorovným rohovým převodem se zvyšuje oblast použití o 250 mm.

<sup>2</sup> Není použitelné ve spojení s falcovým křídlovým dílem bez UV.

103625



s koncovkou Typ 1

103626



s koncovkou Typ 2

### 12.13 Omezovače otvírání MULTI POWER



No



No  
Tricoat

stříbrné	DŘEVO Eurofalz	330 - 1.400	150	20	103623 <sup>1</sup>	103778 <sup>1</sup>
	DŘEVO Euronut	330 - 1.400	150	20	103624 <sup>1</sup>	
	PVC s koncovkou Typ 1	330 - 1.400	150	20	103625 <sup>1</sup>	103780 <sup>1</sup>
	PVC s koncovkou Typ 2	330 - 1.400	150	20	103626 <sup>1</sup>	

<sup>1</sup> s vodorovným rohovým převodem je oblast použití od 560 mm.

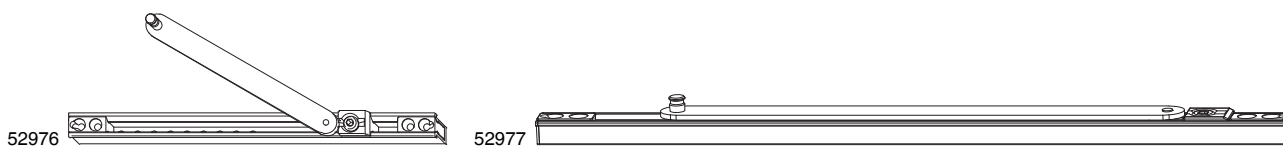
## 12.14 Omezovače otvírání



12.14.1 Omezovače otvírání		L			No	No Tricoat
stříbrné	omezovače otvírání s brzdou raménko 145 mm	244	280 - 380	20	52976 <sup>1,2</sup>	201784 <sup>1,2*</sup>
	omezovače otvírání s brzdou raménko 210 mm	244	360 - 449	20	216367 <sup>1,2</sup>	
	omezovače otvírání s brzdou raménko 250 mm	244	381 - 470	20	52978 <sup>2</sup>	202432 <sup>2*</sup>
	omezovače otvírání s brzdou raménko 250 mm	333	471 - 1.650	20	52977 <sup>2,3</sup>	201774 <sup>2,3*</sup>
	omezovače otvírání s brzdou raménko 274 mm	333	480 - 1.800	20	214328 <sup>2,4</sup>	223210 <sup>2,4</sup>

<sup>1</sup> křídlový díl spodního ložiska odstřihnout u značky.

<sup>2</sup> Ve spojení s vodorovným rohovým převodem se zvyšuje oblast použití o 250 mm.

<sup>3</sup> Ve spojení s Multi Power AWB 470 - 1400 mm.

<sup>4</sup> Ve spojení s 180 kg AWB od 695 mm.

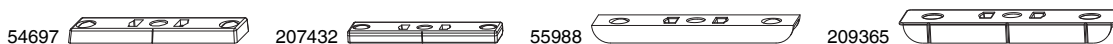

12.14.2 Rámový díl pro omezovač otevírání		L		No	No Tricoat
stříbrné	rámový díl pro omezovač otevírání pro PVC	78	50	10757	101408
	rámový díl pro omezovač otevírání Eurofalz 18 mm šikmé prošroubování	80	50	54697	201785
	rámový díl pro omezovač otevírání Eurofalz 20 mm šikmé prošroubování	80	50	207432	212218
	rámový díl pro omezovač otevírání pro 4 mm Falzluft 9 přesah šikmé prošroubování	90	50	55988 <sup>1,2</sup>	208788 <sup>1,2</sup>
	rámový díl pro omezovač otevírání pro 4 mm Falzluft 13 přesah	90	100	209365 <sup>2,3</sup>	

<sup>1</sup> 18 mm hloubka frézování.

<sup>2</sup> délka frézování 90 mm.

<sup>3</sup> 22 mm hloubka frézování.

## 12.15 Stavěč křídla Komfort





105428

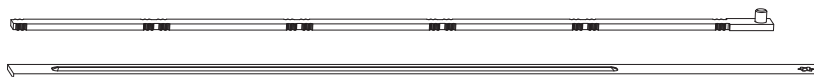

105429



12.15.1 Stavěč křídla Komfort		L			N <sup>o</sup>	N <sup>o</sup> Tricoat
stříbrné	Stavěč křídla Komfort s raménkem 145 mm vel. 1	250	566 - 800	20	<b>105428</b> <sup>1,2</sup>	
	Stavěč křídla Komfort s raménkem 250 mm vel. 2	250	660 - 1.800	20	<b>105429</b> <sup>1,3</sup>	

<sup>1</sup> Použít doplňkové zvedací a zabezpečovací zařízení pro komfortní stavěč Obj. Č. 370922!

<sup>2</sup> FFB je pro rohový křídlový pant, ne pro falcový křídlový pant!

<sup>3</sup> FFB pro falcový křídlový pant; 670mm pro Multi Power.

229225

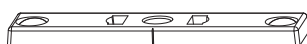

228451



228785

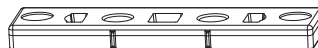





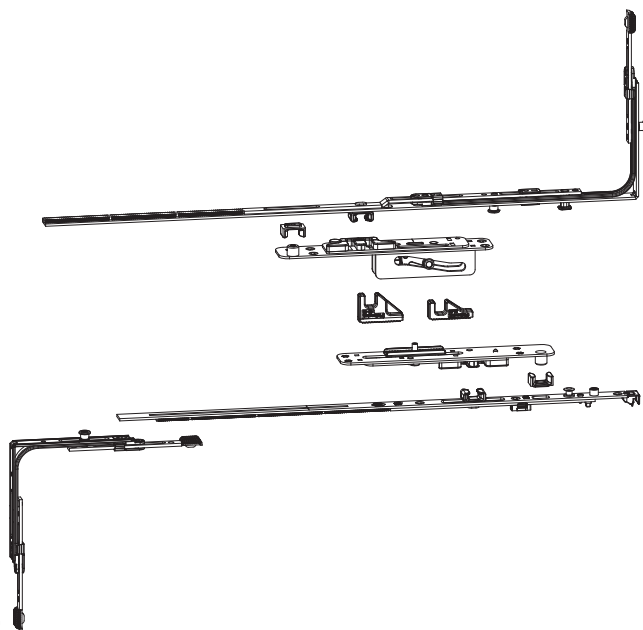

10757



12.15.2 Rámové díly pro stavěč křídla Komfort			N <sup>o</sup>	N <sup>o</sup> Tricoat
stříbrné	rámový díl pro stavěč křídla Komfort pro DŘEVO 12L šikmé prošroubování FT18	50	<b>229225</b>	
	rámový díl pro omezovač otevírání für DŘEVO 12L šikmé prošroubování FT20 a FT24	50	<b>228451</b>	
	rámový díl pro stavěč křídla Komfort pro PVC Multi Power	50	<b>228785</b>	
	rámový díl pro omezovač otevírání pro PVC	50	<b>10757</b>	



105359

12.16 MULTI SKY kování pro světlíky								
					kg		No	Tricoat
stříbrné	pravé	13V	600 - 1.300	500 - 800	30	1	105359 <sup>1,2</sup>	
	levé	13V	600 - 1.300	500 - 800	30	1	105360 <sup>1,3</sup>	

<sup>1</sup> DŮLEŽITÉ: Pro pravé středové křídlo si objednejte levou verzi Multi Sky a naopak!

<sup>2</sup> Skládá se z: posuvné kulisy horní pravé, posuvné kulisy spodní pravé, otevíravého štlupu zakratitelného MM 600 FFB 430-600, rohový převod prodloužitelný, rohový převod MM s 1 i.S. FFB 320-1650, 2 ks fixační patka, ovládací díl pro kulisu s odstupem destičky 43-48 mm.





<sup>3</sup> Skládá se z: posuvné kulisy horní levé, posuvné kulisy spodní levé, otevíravého štlupu zakratitelného MM 600 FFB rohový převod MM s 1 i.S. FFB 320-1650, 2 ks fixační patka, ovládací díl pro kulisu s odstupem destičky 43-48 mm.

209774

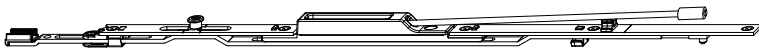

215159



12.17 SAFETY PIN zajištění proti vypadnutí						
					No	Tricoat
stříbrné		střední závory pro přechod TR - MM 125 s 1iS	280 - 2.800	20	206538	
		záchytné pojistky spodní		20	209774 <sup>1</sup>	223236 <sup>1</sup>
		záchytné pojistky pro PVC horní prodloužitelné 1iS		20	215159	223245
žluté	pravé	zavěsné desky pro záchytné zajištění šikmé prošroubování s pozičními čepy pro DŘEVO a PVC		20	102301	105154
	levé	zavěsné desky pro záchytné zajištění šikmé prošroubování s pozičními čepy pro DŘEVO a PVC		20	102302	
bílé		podložky pro zavěsné desky PVC 2 mm		50	363605	
		podložky pro zavěsné desky PVC 3 mm		50	363606	

<sup>1</sup> Musí být použito od FFH 1850 mm!

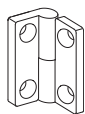

11154

<b>H 12.19 Závěsy mřížek</b>			<b>No</b>	<b>No</b> Tricoat
bílé	pravé	50	<b>11472</b>	
	levé	50	<b>11473</b>	
hnědé	pravé	50	<b>11154</b>	
	levé	50	<b>11155</b>	



10992

<b>H 12.20 Spojky mřížek</b>			<b>No</b>	<b>No</b> Tricoat
bílé	pro šprosnový kříž/šprosnový rám 26 mm	50	<b>11470<sup>1</sup></b>	
	pro šprosnový kříž 33 mm	50	<b>11471</b>	
hnědé	pro šprosnový kříž/šprosnový rám 22 mm	50	<b>13130<sup>1</sup></b>	
	pro šprosnový kříž/šprosnový rám 26 mm	50	<b>11153<sup>1</sup></b>	
	pro šprosnový kříž 33 mm	50	<b>10992</b>	

<sup>1</sup> Lze kombinovat se závěsy mřížek.

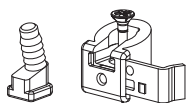



12387

<b>H 12.21 Spojky mřížek k zavrtání</b>			<b>No</b>	<b>No</b> Tricoat
bílé		50	12388 <sup>1</sup>	
hnědé		50	12387 <sup>1</sup>	

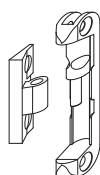
<sup>1</sup> 25 ks levé a pravé.



101251

<b>H 12.22 Universal-závěsy</b>				<b>No</b>	<b>No</b> Tricoat
stříbrné	s 2 mm Luft	40	50	101248	
	bez Luftu	40	50	101251	

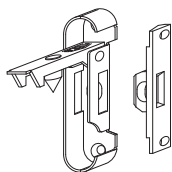

101252

<b>H 12.23 Universal-spojky</b>			<b>No</b>	<b>No</b> Tricoat
stříbrné	s 2 mm Luft	50	101250	
	bez Luftu	50	101252	

367617 

<b>12.24 Kování pro hliníkové opláštění</b>			<b>No</b>	<b>No</b> Tricoat
Tricoat	uzávěr pro Alu-opláštění	20		227956*
	rámový díl pro uzávěr pro Alu-opláštění	20		370051*
	podložka pro rámový díl pro Alu-opláštění	20		370052*
	předrámečková ložiska pro Alu-opláštění	20		366613 <sup>1</sup> *
	předrámečkové závěsy pro Alu-opláštění 15 mm výška	20		366614*
	předrámečkové závěsy pro Alu-opláštění 16 mm výška	20		366615*
	čep pro závěs	20		367617 <sup>1</sup> *



<sup>1</sup> Šroub pro aretaci čepu obj. č. 104302 objednávejte zvlášť.

94022  44351  44350 

<b>H 12.25 Falcové náběhy</b>					<b>No</b>	<b>No</b> Tricoat
stříbrné	náběhy	4L		500	<b>94022<sup>1</sup></b>	
	falcové náběhy		křídlový díl	50	<b>44351<sup>1</sup></b>	
			rámový díl	50	<b>44350<sup>1</sup></b>	

<sup>1</sup> Jen pro Eurofalz FT20.

370252  369791 

<b>K 12.26 Náběhy pro prahy</b>					<b>B</b>	<b>L</b>		<b>No</b>	<b>No</b> Tricoat
stříbrné		rámový díl	8	21,8	50	100	<b>370252<sup>1</sup></b>		
				23,5	50	100	<b>371009<sup>2</sup></b>		
				27,3	50	100	<b>371712<sup>3</sup></b>		
				28	50	100	<b>370390<sup>4</sup></b>		
				33,9	50	100	<b>369788<sup>5</sup></b>		
šedé F1		křídlový díl		4L	20	20	100	<b>369791</b>	
				6L	20	20	100	<b>369790</b>	
				10L	20	20	100	<b>369789</b>	

<sup>1</sup> TROCAL a GKG

<sup>2</sup> MACO TRANSIT

<sup>3</sup> Schüco Living

<sup>4</sup> Eifel TB

<sup>5</sup> VEKA

362918   101473   104371  

<b>12.27 Vrutky</b>		<b>L</b>	<b>Ø</b>		<b>No</b>	<b>No</b> Tricoat
stříbrné	spec.vrt.šrouby pro MP DŘEVO a PVC Philips hlava 7,2mm	38	4,5	100	<b>362918</b>	<b>105152*</b>
	spec.vrt.šrouby pro MP DŘEVO a PVC TX20 hlava 7,2mm	38	4,5	500	<b>367828</b>	<b>104212*</b>
Tricoat	šrouby do kování pro PVC s vrtacím hrotem Tricoat	25	3,9	100		<b>101474*</b>
		32	3,9	100		<b>101473*</b>
		38	3,9	100		<b>101472*</b>
	šrouby do kování Phillips 7mm hlava pro dřevo a PVC Tricoat	22	4,2	100		<b>101466*</b>
		25	4,2	100		<b>104371*</b>
		30	4,2	100		<b>101469*</b>
		40	4,2	100		<b>101470*</b>
	55	4,2	500		<b>102269*</b>	

41823



### 12.28 Bezpečnostní podložka

Bezpečnostní podložka DIN 6799



**No**

**No**  
Tricoat

1.000

**41823**

206692 

### 12.29 Zubové spojky MM

stříbrné



**No**

**No**  
Tricoat

50

**206692<sup>1</sup>**

<sup>1</sup> Dodávky také pod balicím množstvím.



355920 

<b>12.30 Nástrčná pouzdra pro i-S čepy pro 3kř. okna</b>		<b>No</b>	<b>No</b> Tricoat
stříbrné	100	<b>355920</b>	

364686 

<b>12.31 Krycí štulpy</b>	<b>L</b>		<b>No</b>	<b>No</b> Tricoat
stříbrné	1.400	10	<b>364686</b>	
	2.200	10	<b>364687</b>	





## 15 MACO TRONIC

---

### 15.1 Monitorování oken

---

- 15.1.1 Křídlové díly pro monitorování uzavření
- 15.1.2 Rámové díly/senzory pro monitorování uzavření
- 15.1.3 Příslušenství pro monitorování oken

## 15 MACO TRONIC



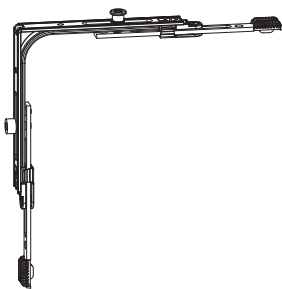

### 15.1 Monitorování oken

#### 15.1.1 Křídlové díly pro monitorování uzavření

##### 15.1.1.1 Rohové převody s magnetem



206190

15.1.1.1.1 Rohové převody s magnetem						
stříbrné	s 1 i.S. a 1 magnetem	320 - 1.650	360 - 2.450	50	206190	209920





228493



15.1.1.1.2 Rohové převody s magnetem svislé					
stříbrné	svislé prodlužitelné s 1 magnetem	750 - 2.450	50	228493	



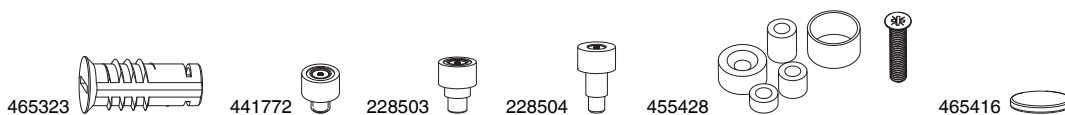

201755

15.1.1.2 Prodloužení štulpu prodlužitelné MM s magnetem				
stříbrné	140 s 1 magnetem	20	201755	209921

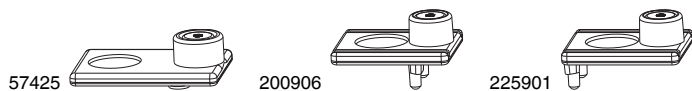

15.1.1.3 Magnety a příslušenství				
stříbrné	magnety našroubovatelné v zinkovém opláštění	100	465323	
	magnety M5 Ø 10x10 mm	100	441772	
	magnety krátké Ø 10x13,4 mm	100	228503	
	magnety dlouhé Ø 10x17,7 mm	100	228504	
bílé	magnety našroubovatelné	10	455428	
blank	magnetové podložky Ø 8x1 mm	200	465416	



15.1.1.4 Adaptéry s magnetem			No	No Tricoat
šedé	adaptéry s magnetem	50	57425	
	adaptéry s magnetem KVS MM	50	200906	
	adaptéry s magnetem KVS MM automat.	10	225901	

## 15.1.2 Rámové díly/senzory pro monitorování uzavření

### 15.1.2.1 Kabelové senzory

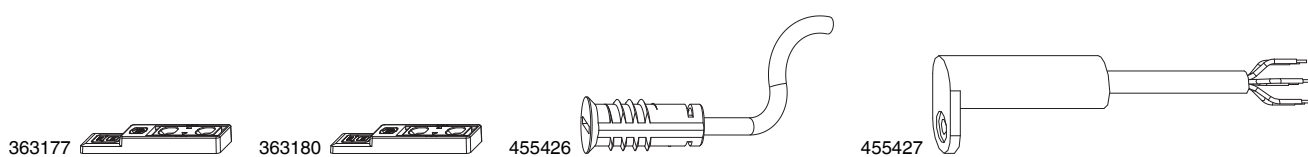

15.1.2.1.1 Reedkontakt			No	No Tricoat	
šedé	RVS pro kontrolu uzavření a vyklopení	VdS B/C	Kabel 6 m (0,14 mm <sup>2</sup> )	10	363177
			Kabel 10 m (0,14 mm <sup>2</sup> )	10	363178
			Kabel 15 m (0,14 mm <sup>2</sup> )	10	363179 <sup>1</sup>
	RHS pro ovládání topení		Kabel 6 m (0,14 mm <sup>2</sup> )	10	363180
			Kabel 15 m (0,14 mm <sup>2</sup> )	10	363181
stříbrné	MVE pro kontrolu uzavření a vyklopení	VdS C	Kabel 6 m (0,14 mm <sup>2</sup> )	10	455426
		MVF pro kombinaci kontroly otevření a uzavření	VdS C	Kabel 6 m (0,14 mm <sup>2</sup> )	10

<sup>1</sup> Reedkontakt pro kontrolu uzavření RVS Kabel 15 m nemá VdS - schválení.

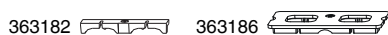

15.1.2.1.2 Tvarové podložky pro Reedkontakt			No	No Tricoat
bílé	Typ 1	10	363182 <sup>1</sup>	
	Typ 2	10	363183 <sup>1</sup>	
	Typ 3	10	363184 <sup>1</sup>	
	Typ 4	10	363185 <sup>1</sup>	
	Typ 5	10	363186 <sup>1</sup>	
	Typ 6	10	363187 <sup>1</sup>	
	Typ 7	10	370482 <sup>1</sup>	

<sup>1</sup> Odpovídající podložky pro váš profil naleznete v profilových listech.

### 15.1.2.2 Bezdrátové senzory



15.1.2.2.1 mTRONIC			No	No Tricoat
světle šedá RAL 7035	mTRONIC Multisensor bezdrátový	10	476776	

### 15.1.3 Příslušenství pro monitorování oken

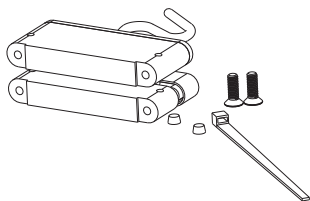

458062

#### 15.1.3.1 Snímače elektronické bezkontaktní



No

No  
Tricoat

pro senzory rozbití skla

1

458062

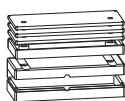

455431

455429



#### 15.1.3.2 Příslušenství přechodu



No

No  
Tricoat

bílé

sady vestavného krytu pro bezkontaktní elektronický přechod

1

455431

upevnění rámu pro bezkontaktní elektronický přechod

1

455429

hnědé

sady vestavného krytu pro bezkontaktní elektronický přechod

1

455432

upevnění rámu pro bezkontaktní elektronický přechod

1

455430

458281



363472



363473

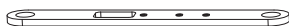

363474



#### 15.1.3.3 Rozebíratelná kabelové přechodky



No

No  
Tricoat

odpojitelné kabelové přechodky 6-polové kabel 1m/2m

1

458281

odpojitelné kabelové přechodky pro Alarmspinne kabel 6m (0,14mm<sup>2</sup>)

1

363472

nerez

krycí plechy kabelového přechodu DŘEVO

1

363473

krycí plechy kabelového přechodu PVC pro Alarmspinne

1

363474



# Všechno z jednoho zdroje?

Nabízíme kompletní řešení pro velkoplošné systémy, okna a dveře - na dřevo, PVC a hliník.  
Zažijte naši univerzální nabídku systému, včetně komplexních služeb. Další informace naleznete na  
našich webových stránkách [www.maco.eu](http://www.maco.eu) nebo kontaktujte svého obchodního poradce MACO.



## MACO in Ihrer Nähe:

[www.maco.eu/kontakt](http://www.maco.eu/kontakt)



TECHNIKA V POHYBU



Tento tiskový dokument podléhá průběžným změnám.  
Jeho aktuální vydání naleznete na <https://www.maco.eu/assets/759107>  
případně oskenujte QR kód.

Datum: 11/2020  
obj. č. 759107

Všechna práva vyhrazena. Změny vyhrazeny.